



SAGAJI INFORMA 2025



ALTIMA

Los artículos publicados en esta edición están sujetos a disponibilidad o hasta agotar existencias. Las imágenes son ilustrativas y pueden variar.



¡Seguro tenemos lo que necesita!



Guía de lectura

ÍNDICE

1. Ubique el sistema automotriz que sea de su interés para iniciar la consulta de refacciones aplicables al vehículo, por ejemplo, afinación, clutch, etc.

Los sistemas automotrices están ordenados alfabéticamente, lo que facilita la consulta de esta publicación.

2. Localice la categoría específica de las refacciones que desea consultar para identificar la o las páginas en donde encontrará los códigos o números de parte disponibles para el vehículo que da título a esta publicación.

CONSULTA

1. Una vez que se encuentre en la página de la categoría de producto de su interés, identifique la refacción que requiere consultar de acuerdo con el siguiente orden:
 - a. Nombre de la refacción.
 - b. Código o número de parte (el orden de lectura es alfanumérico).
 - c. Marca del producto.
 - d. Aplicación por año o modelo, motor y cilindraje.
 - e. Equivalencias en otras marcas.
 - f. Especificaciones adicionales.

a	TORNILLO ESTABILIZADOR	UD2116019	b
		2012-2019 1.6 L4	d
		2020-2023 1.6 L4	d
		- - -	
		- - -	
		Equivalencias	
		DAI MOOG	e
		SD2116019 K750098	e
		Especificaciones	
c		DELANTERO IZO/DER	f

IMPORTANTE: Cada producto publicado muestra tanto la fotografía, como la marca con mayor demanda y disponibilidad.

Esta publicación podría tener algún error en aplicación, número de parte, especificaciones, fotografía, entre otros.

Todas las refacciones impresas en esta edición están sujetas a disponibilidad o bien a compra sobre pedido. Por favor valide existencias en nuestra página de comercio electrónico o con su Asesor Comercial SGAJI.



Índice

AFINACIÓN

Bujías doble platino	1
Bujías iridium	1,2
Bujía platino	2
Bujías resistiva	2
Filtros aceite	2,3
Filtros aire	3,4
Filtros cabina	4,5
Filtros combustible	5
Válvula pcv	5

CLUTCH

Chicotes clutch	5
Cilindros esclavo	5

ELÉCTRICO

Bobinas	6,7
Bombas gasolina	7
Bulbos aceites	8
Bulbos frenos	8
Cables bujía	8,9
Capuchones bobina	9
Cedazo bomba gasolina	9
Cuerpos aceleración	9,10
Distribuidor	10
Inyector	10
Módulos bombas gasolina	10
Repuestos bombas gasolina	10
Repuestos inyectores	11
Rotor distribuidor	11
Sensores ckp	11,12
Sensores cmp	12
Sensores cts	13
Sensor iat	13
Sensores ks	13
Sensores maf	13,14
Sensores oxígeno	14,15,16
Sensor posición	16
Sensores temperatura motor	16
Sensores tps	17
Sensores vss	17
Válvulas vvt	17,18

ENFRIAMIENTO

Bandas micro v	18,19
Bombas agua	20
Mangueras radiador	21
Poleas locas	21,22
Radiadores	22
Tapones radiador	22
Tensores banda accesorios	22,23
Termostatos	23
Tomas agua	23,24

FRENOS

Balatas disco	24,25,26
Chicotes frenos	26
Cilindros maestros	26,27
Cilindro rueda	27
Discos	27

FRENOS

Kits caliper	28
Kit tambor	28

MOTOR

Anillos	28,29,30
Bombas aceites	30,31,32
Buje biela	32
Camisas	32
Guía válvula	32
Juegos juntas motor	32,33,34
Juntas cabeza	34,35
Juntas carter	35
Juntas distribución	36
Junta escape	36
Juntas múltiples admisión	36,37
Juntas múltiples escape	37,38
Juntas pleno	38
Juntas punterías	38,39
Kits distribución	39,40
Lainas cabeza	40
Metales biela	41,42
Metales cigüeñales	42,43,44
Pistones	44,45,46
Polea cigüeñal	46
Puntería	46
Repuestos bombas aceite	46
Repuestos soportes motor	46,47
Retenes cigüeñales	47,48
Retenes distribución	48
Sello tubo bujía	48
Sellos válvulas	48,49
Soportes motor	49,50,51
Tapones monoblock	51
Tornillo cabeza	52
Válvulas admisión	52
Válvulas escape	52,53

SUSPENSIÓN Y DIRECCIÓN

Amortiguadores gas	53,54,55
Bases amortiguador	55,56
Bieleta	56,57
Bombas dirección hidráulica	57
Buje	57
Bujes horquillas	57,58
Bujes inferiores	58
Cubres polvo	58,59
Goma barra	59
Horquillas	59,60
Kit tope rebote	60
Resortes suspensión	60
Terminales dirección	60,61
Topes rebote	61
Tornillos estabilizadores	61,62,63

TREN MOTRIZ

Balero	63
Baleros doble	63
Espiga lado caja	63

Índice

TREN MOTRIZ

Espigas lado rueda.....	63,64
Filtros transmisión.....	64
Machetas.....	64
Retenes rueda.....	64,65
Retenes transmisión.....	65
Soportes transmisión.....	65,66

UNIVERSAL

Plumas limpiaparabrisas.....	66,67
------------------------------	-------



**¡Seguro tenemos
lo que necesita!**

Conozca

Nuestra plataforma
de comercio en línea



AFINACIÓN



BUJÍA DOBLE PLATINO

7975



2002-2006	2.5	L4
2002-2006	3.5	V6
-	-	-
-	-	-

Equivalencias

-	-
-	-

Especificaciones

-	-
-	-

BUJÍA DOBLE PLATINO

RC12PYP



1993-2001	2.4	L4
-	-	-
-	-	-
-	-	-

Equivalencias

-	-
-	-

Especificaciones

-	-
-	-

BUJÍA DOBLE PLATINO

REA8PMPB5



2007-2012	2.5	L4
2007-2017	3.5	V6
-	-	-
-	-	-

Equivalencias

-	-
-	-

Especificaciones

-	-
-	-

BUJÍA IRIIDIUM

9006



2002-2006	2.5	L4
2002-2006	3.5	V6
-	-	-
-	-	-

Equivalencias

-	-
-	-

Especificaciones

-	-
-	-

BUJÍA IRIIDIUM

9201



1993-2001	2.4	L4
-	-	-
-	-	-
-	-	-

Equivalencias

-	-
-	-

Especificaciones

-	-
-	-

BUJÍA IRIIDIUM

9410



2013-2018	2.5	L4
2018-2018	3.5	V6
-	-	-
-	-	-

Equivalencias

-	-
-	-

Especificaciones

-	-
-	-

BUJÍA IRIIDIUM

9412



2007-2012	2.5	L4
2007-2017	3.5	V6
-	-	-
-	-	-

Equivalencias

-	-
-	-

Especificaciones

-	-
-	-



BUJÍA IRIDIUM	REA12WMB4
	2007-2024 2.5 L4
	- - -
	- - -
	- - -
Equivalencias	
-	
Especificaciones	
-	

BUJÍA PLATINO	3071
	1993-2001 2.4 L4
	- - -
	- - -
	- - -
Equivalencias	
-	
Especificaciones	
-	

BUJÍA RESISTIVA	MAGSP32C
	1993-2001 2.4 L4
	- - -
	- - -
	- - -
Equivalencias	
CHAMPION	-
RC12YC	-
Especificaciones	
-	

Motorcraft.

BUJÍA RESISTIVA	RC12YC
	1993-2001 2.4 L4
	- - -
	- - -
	- - -
Equivalencias	
MOTORCRAFT	-
MAGSP32C	-
Especificaciones	
-	

BUJÍA RESISTIVA	REA8MCX
	2007-2012 2.5 L4
	- - -
	- - -
	- - -
Equivalencias	
-	
Especificaciones	
-	

BUJÍA RESISTIVA	REC10YC4
	2002-2006 2.5 L4
	- - -
	- - -
	- - -
Equivalencias	
-	
Especificaciones	
-	

FILTRO ACEITE	GPS149
	2002-2008 2.5 L4
	2002-2006 3.5 V6
	1995-2001 2.4 L4
	- - -
Equivalencias	
-	
Especificaciones	
SINTÉTICO	

GONHER.

FILTRO ACEITE	GPS91
	2019-2024 2.0 TURBO L4
	2009-2024 2.5 L4
	2007-2018 3.5 V6
	- - -
Equivalencias	
-	
Especificaciones	
SINTÉTICO	

GONHER.



Mayoreo en autopartes

FILTRO ACEITE	OF6607
	2002-2024 2.5 L4
	1993-2001 2.4 L4
	- - -
	- - -
Equivalencias	
-	
Especificaciones	
-	

FILTRO ACEITE	OF6607STX
	2002-2024 2.5 L4
	1993-2001 2.4 L4
	- - -
	- - -
Equivalencias	
-	
Especificaciones	
SINTÉTICO	

FILTRO ACEITE	U00GP149
	2002-2008 2.5 L4
	2002-2006 3.5 V6
	1995-2001 2.4 L4
	- - -
Equivalencias	
GONHER GP149	MOTORCRAFT MFL2013
Especificaciones	
-	

FILTRO ACEITE	U00GP91
	2019-2024 2.0 TURBO L4
	2009-2024 2.5 L4
	2007-2018 3.5 V6
	- - -
Equivalencias	
GONHER GP91	MOTORCRAFT MFL2018
Especificaciones	
-	



FILTRO AIRE	SGA10349
	2007-2013 2.5 L4
	- - -
	- - -
	- - -
Equivalencias	
INTERFIL F103A49	GONHER GA1530
Especificaciones	
-	

FILTRO AIRE	SGA2376
	2019-2024 2.5 L4
	- - -
	- - -
	- - -
Equivalencias	
INTERFIL F109A47	GONHER GA2376
Especificaciones	
-	

FILTRO AIRE	SGA4309
	2002-2024 2.5 L4
	2002-2018 3.5 V6
	1993-2001 2.4 L4
	- - -
Equivalencias	
INTERFIL F43A09	GONHER GAD15
Especificaciones	
-	

FILTRO AIRE	SGA5463
	2013-2018 2.5 L4
	- - -
	- - -
	- - -
Equivalencias	
INTERFIL F54A63	GONHER GA1531
Especificaciones	
-	



FILTRO AIRE	SGA66CB
	2019-2024  2.0 TURBO  L4
	-  -  -
	-  -  -
	-  -  -
	-  -  -
Equivalencias	
INTERFIL F66ACB	-
Especificaciones	
-	



FILTRO CABINA	CFI2725
	1998-2001  2.4  L4
	-  -  -
	-  -  -
	-  -  -
	-  -  -
Equivalencias	
-	-
Especificaciones	
-	



FILTRO CABINA	CFI2776CA
	2019-2024  2.0 TURBO  L4
	2019-2024  2.5  L4
	-  -  -
	-  -  -
	-  -  -
Equivalencias	
-	-
Especificaciones	
CARBÓN ACTIVADO	



FILTRO CABINA	CFI7727
	2007-2012  2.5  L4
	2002-2018  3.5  V6
	-  -  -
	-  -  -
	-  -  -
Equivalencias	
-	-
Especificaciones	
-	











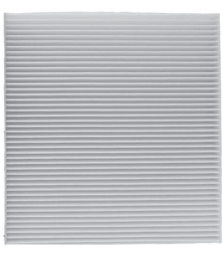



FILTRO CABINA	CFI999M
	2002-2006  2.5  L4
	-  -  -
	-  -  -
	-  -  -
	-  -  -
Equivalencias	
GONHER GAC99	-
Especificaciones	
-	







FILTRO CABINA	CFI999MCA
	2002-2006  2.5  L4
	2002-2018  3.5  V6
	-  -  -
	-  -  -
	-  -  -
Equivalencias	
-	-
Especificaciones	
CARBÓN ACTIVADO	



FILTRO CABINA	GAC99
	2002-2006  2.5  L4
	-  -  -
	-  -  -
	-  -  -
	-  -  -
Equivalencias	
INTERFIL CFI999M	-
Especificaciones	
-	



FILTRO CABINA	UFC2463
	2013-2018  2.5  L4
	-  -  -
	-  -  -
	-  -  -
	-  -  -
Equivalencias	
GONHER GAC2463	-
Especificaciones	
-	





FILTRO COMBUSTIBLE

S1037



1993-2001	2.4	L4
2002-2009	3.5	V6
2002-2006	2.5	L4
-	-	-

Equivalencias

INTERFIL FGI37	GONHER GG137
-------------------	-----------------

Especificaciones

VÁLVULA PCV

SG57



1994-1997	2.4	L4
-	-	-
-	-	-
-	-	-

Equivalencias

TOMCO TM57	-
---------------	---

Especificaciones

CLUTCH



CHICOTE CLUTCH

NI306



1996-1998	-	-
-	-	-
-	-	-
-	-	-

Equivalencias

-	-
---	---

Especificaciones

LONG.74

CHICOTE CLUTCH

NI307



1995-1996	-	-
-	-	-
-	-	-
-	-	-

Equivalencias

-	-
---	---

Especificaciones

LONG.742

CILINDRO ESCLAVO

U360139L



2004-2006	3.5	V6
-	-	-
-	-	-
-	-	-

Equivalencias

-	-
---	---

Especificaciones

11/16 PULG

CILINDRO ESCLAVO

U37928L



1993-1999	2.4	L4
-	-	-
-	-	-
-	-	-

Equivalencias

-	-
---	---

Especificaciones

3/4 PULG

ELÉCTRICO







BOBINA	ICK1101
	2013-2018 2.5 L4
	- - -
	- - -
	- - -
Equivalencias	
-	-
Especificaciones	
3 TERMINALES	
	

BOBINA	ICK1133
	2007-2012 2.5 L4
	- - -
	- - -
	- - -
Equivalencias	
HITACHI IGC0002	-
Especificaciones	
-	
	

BOBINA	ICK1138
	2007-2018 3.5 V6
	- - -
	- - -
	- - -
Equivalencias	
HITACHI IGC0099	-
Especificaciones	
-	
	

BOBINA	ICK115
	1993-1997 2.4 L4
	- - -
	- - -
	- - -
Equivalencias	
-	-
Especificaciones	
-	
	

BOBINA	ICK123
	2002-2006 2.5 L4
	- - -
	- - -
	- - -
Equivalencias	
IEA P51398	HITACHI IGC0008
Especificaciones	
-	
	

BOBINA	ICK126
	2002-2006 3.5 V6
	- - -
	- - -
	- - -
Equivalencias	
-	-
Especificaciones	
-	
	

BOBINA	IGC0002
	2007-2012 2.5 L4
	- - -
	- - -
	- - -
Equivalencias	
KEM ICK1133	-
Especificaciones	
3 PINES	
HITACHI	

BOBINA	IGC0008
	2002-2006 2.5 L4
	- - -
	- - -
	- - -
Equivalencias	
IEA P51398	KEM ICK123
Especificaciones	
3 PINES	
HITACHI	





BOBINA	IGC0099
	2007-2018 3.5 V6
	- - -
	- - -
	- - -
Equivalencias	
KEM ICK1138	- -
Especificaciones	
3 PINES	
HITACHI	

BOBINA	P51398
	2002-2006 2.5 L4
	- - -
	- - -
	- - -
Equivalencias	
HITACHI IGC0008	KEM ICK123
Especificaciones	
3 PINES	
iea <small>Electric & Electronic Components</small>	

BOBINA	P51406
	2002-2017 3.5 V6
	- - -
	- - -
	- - -
Equivalencias	
-	-
Especificaciones	
3 PINES	
iea <small>Electric & Electronic Components</small>	

BOBINA	P5933
	1995-1996 2.4 L4
	- - -
	- - -
	- - -
Equivalencias	
-	-
Especificaciones	
2 PINES	
iea <small>Electric & Electronic Components</small>	

BOMBA GASOLINA	EU42229
	1997-2001 2.4 L4
	- - -
	- - -
	- - -
Equivalencias	
-	-
Especificaciones	
REPUESTO	
uniflow	

BOMBA GASOLINA	EU42280
	1993-1996 2.4 L4
	- - -
	- - -
	- - -
Equivalencias	
UNIFLOW U52235	- -
Especificaciones	
REPUESTO	
uniflow	

BOMBA GASOLINA	EU55287
	2004-2012 2.5 L4
	2004-2012 3.5 V6
	- - -
	- - -
Equivalencias	
KEM 5216E	- -
Especificaciones	
-	
uniflow	

BOMBA GASOLINA	U52235
	1993-1996 2.4 L4
	- - -
	- - -
	- - -
Equivalencias	
UNIFLOW EU42280	- -
Especificaciones	
REPUESTO	
uniflow	



BULBO ACEITE	PS131
 <p>KEMPARTS</p>	1993-2001 2.4 L4 2002-2006 3.5 V6 - - - - - -
	Equivalencias
	-
	Especificaciones
INDICADOR DE LUZ 1 TERMINAL CUERDA M10X0.9 MÉTRICA	

BULBO ACEITE	PS337
 <p>KEMPARTS</p>	2002-2013 2.5 L4 2007-2013 3.5 V6 - - - - - -
	Equivalencias
	-
	Especificaciones
INDICADOR DE LUZ 1 TERMINAL	

BULBO ACEITE	PS513
 <p>KEMPARTS</p>	2002-2014 2.5 L4 2002-2014 3.5 V6 - - - - - -
	Equivalencias
	-
	Especificaciones
3 TERMINALES	

BULBO FRENO	EGK708
 <p>KEMPARTS</p>	2007-2010 2.5 L4 2007-2010 3.5 V6 - - - - - -
	Equivalencias
	-
	Especificaciones
4 TERMINALES	

BULBO FRENO	EGK719
 <p>KEMPARTS</p>	2011-2012 2.5 L4 - - - - - - - - -
	Equivalencias
	-
	Especificaciones
4 TERMINALES	



BULBO FRENO	EGK723
 <p>KEMPARTS</p>	1996-2001 2.4 L4 2002-2002 2.5 L4 2002-2002 3.5 V6 - - -
	Equivalencias
	-
	Especificaciones

BULBO FRENO	EGK732
 <p>KEMPARTS</p>	2019-2022 2.0 TURBO L4 2013-2022 2.5 V6 2013-2018 3.5 V6 - - -
	Equivalencias
	-
	Especificaciones
4 TERMINALES	



CABLE BUJÍA	CB202
 <p>KEM</p>	1993-1996 2.4 L4 - - - - - - - - -
	Equivalencias
	KEM L2104
	Especificaciones
7 MM MAG PLUS (SILICÓN) ENCENDIDO ELECTRÓNICO	



CABLE BUJÍA		L2104	
📅	1993-1996	🏠	2.4 L4
📅	-	🏠	-
📅	-	🏠	-
📅	-	🏠	-
Equivalencias			
KEM	-		
CB202	-		
Especificaciones			
EPS GROSOR 7 MM C/5 PZS			



CABLE BUJÍA		L2112	
📅	1997-2001	🏠	2.4 L4
📅	-	🏠	-
📅	-	🏠	-
📅	-	🏠	-
Equivalencias			
-	-		
-	-		
Especificaciones			
EPS GROSOR 7 MM C/4 PZS			

CAPUCHÓN BOBINA		CH163K	
📅	2013-2019	🏠	2.5 L4
📅	-	🏠	-
📅	-	🏠	-
📅	-	🏠	-
Equivalencias			
-	-		
-	-		
Especificaciones			
4 CAPUCHONES C/RESORTE ENCENDIDO ELECTRÓNICO			



CAPUCHÓN BOBINA		CH66	
📅	2002-2006	🏠	2.5 L4
📅	-	🏠	-
📅	-	🏠	-
📅	-	🏠	-
Equivalencias			
-	-		
-	-		
Especificaciones			
4 CAPUCHONES C/RESORTE ENCENDIDO ELECTRÓNICO			

CAPUCHÓN BOBINA		CH68	
📅	2007-2012	🏠	2.5 L4
📅	-	🏠	-
📅	-	🏠	-
📅	-	🏠	-
Equivalencias			
-	-		
-	-		
Especificaciones			
4 CAPUCHONES C/RESORTE ENCENDIDO ELECTRÓNICO			



CEDAZO BOMBA GASOLINA		F48	
📅	1996-2001	🏠	2.4 L4
📅	-	🏠	-
📅	-	🏠	-
📅	-	🏠	-
Equivalencias			
-	-		
-	-		
Especificaciones			



CUERPO ACCELERACIÓN		T6314	
📅	2007-2012	🏠	2.5 L4
📅	-	🏠	-
📅	-	🏠	-
📅	-	🏠	-
Equivalencias			
-	-		
-	-		
Especificaciones			
DIÁMETRO DEL OBTURADOR 7.1CM			





CUERPO ACCELERACIÓN		T6318	
📅	2002-2006	🏠	3.5 V6
📅	-	🏠	-
📅	-	🏠	-
📅	-	🏠	-
Equivalencias			
-	-		
-	-		
Especificaciones			
ELECTRÓNICO DIAM GARGANTA 8CM			



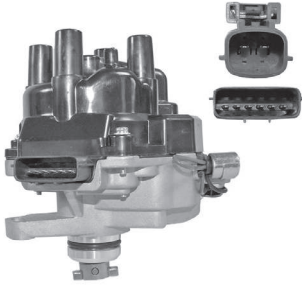

CUERPO ACCELERACIÓN	T6319
	2007-2018 3.5 V6 - - - - - - - - -
Equivalencias	
-	
Especificaciones	
DIÁMETRO DEL OBTURADOR 8CM	
TOMCO	

CUERPO ACCELERACIÓN	T6355
	2013-2021 2.5 L4 - - - - - - - - -
Equivalencias	
-	
Especificaciones	
ELECTRÓNICO DIAM GARGANTA 7.0CM	
TOMCO	

DISTRIBUIDOR	DIS1100
	1997-2001 2.4 L4 - - - - - - - - -
Equivalencias	
-	
Especificaciones	
-	
KEM	

INYECTOR	T15942
	2006-2006 2.5 L4 - - - - - - - - -
Equivalencias	
-	
Especificaciones	
-	
TOMCO	

MÓDULO BOMBA GASOLINA	5202E
	2002-2003 2.5 L4 2002-2003 3.5 V6 - - - - - -
Equivalencias	
-	
Especificaciones	
-	
KEM	

MÓDULO BOMBA GASOLINA	5216E
	2004-2012 2.5 L4 2004-2012 3.5 V6 - - - - - -
Equivalencias	
UNIFLOW EU55287	
Especificaciones	
-	
KEM	

REPUESTO BOMBA GASOLINA	280E
	1996-1996 2.4 L4 - - - - - - - - -
Equivalencias	
-	
Especificaciones	
-	
KEM	

REPUESTO BOMBA GASOLINA	282E
	1996-2001 2.4 L4 - - - - - - - - -
Equivalencias	
-	
Especificaciones	
-	
KEM	



REPUESTO INYECTOR	148001
	2004-2006 3.5 V6 - - - - - - - - -
	Equivalencias
	TOMCO T27102
	Especificaciones

REPUESTO INYECTOR	148034
	1996-1999 2.4 L4 - - - - - - - - -
	Equivalencias
	TOMCO T27034
	Especificaciones

REPUESTO INYECTOR	T27008
	2000-2001 3.5 V6 - - - - - - - - -
	Equivalencias
	- - - -
	Especificaciones

REPUESTO INYECTOR	T27034
	1996-1999 2.4 L4 - - - - - - - - -
	Equivalencias
	KEM PARTS 148034
	Especificaciones

REPUESTO INYECTOR	T27102
	2004-2006 3.5 V6 - - - - - - - - -
	Equivalencias
	KEM PARTS 148001
	Especificaciones
100 PZAS	

ROTOR DISTRIBUIDOR	RH73
	1998-2001 2.4 L4 - - - - - - - - -
	Equivalencias
	- - - -
	Especificaciones
DISTRIBUIDOR HITACHI	

SENSOR CKP	147374
	2007-2019 2.5 L4 2007-2018 3.5 V6 - - - - - -
	Equivalencias
	- - - -
	Especificaciones
3 TERMINALES	

SENSOR CKP	147430
	2002-2006 3.5 V6 - - - - - - - - -
	Equivalencias
	TOMCO T22430
	Especificaciones



SENSOR CKP	147501
	2002-2006 3.5 V6
	- - -
	- - -
	- - -
Equivalencias	
-	-
Especificaciones	
BANCO DERECHO CONECTOR RECTO	
KEMPARTS	

SENSOR CKP	147756
	1998-2001 2.4 L4
	- - -
	- - -
	- - -
Equivalencias	
TOMCO T22331	-
Especificaciones	
-	
KEMPARTS	

SENSOR CKP	T22331
	1998-2001 2.4 L4
	- - -
	- - -
	- - -
Equivalencias	
KEM PARTS 147756	-
Especificaciones	
-	
TOMCO	

SENSOR CKP	T22430
	2002-2006 3.5 V6
	- - -
	- - -
	- - -
Equivalencias	
KEM 147430	-
Especificaciones	
CMP	
TOMCO	

SENSOR CMP	T22250
	2002-2006 2.5 L4
	2002-2006 3.5 V6
	- - -
	- - -
Equivalencias	
TOMCO T22282	-
Especificaciones	
-	
TOMCO	

SENSOR CMP	T22282
	2002-2006 3.5 V6
	2002-2006 2.5 L4
	- - -
	- - -
Equivalencias	
TOMCO T22250	-
Especificaciones	
BLISTER CON DOS PIEZAS	
TOMCO	

SENSOR CMP	T22374
	2007-2019 2.5 L4
	2007-2018 3.5 V6
	- - -
	- - -
Equivalencias	
-	-
Especificaciones	
3 TERMINALES	
TOMCO	

SENSOR CMP	T22456
	2007-2019 2.5 L4
	2007-2018 3.5 V6
	- - -
	- - -
Equivalencias	
-	-
Especificaciones	
3 TERMINALES	
TOMCO	



SENSOR CTS	140729												
	<table border="1"> <tr> <td>2002-2017</td> <td>2.5</td> <td>L4</td> </tr> <tr> <td>2002-2017</td> <td>3.5</td> <td>V6</td> </tr> <tr> <td>-</td> <td>-</td> <td>-</td> </tr> <tr> <td>-</td> <td>-</td> <td>-</td> </tr> </table>	2002-2017	2.5	L4	2002-2017	3.5	V6	-	-	-	-	-	-
2002-2017	2.5	L4											
2002-2017	3.5	V6											
-	-	-											
-	-	-											
Equivalencias													
TOMCO T12053	-												
Especificaciones													
-													
KEMPARTS													

SENSOR CTS	T12053												
	<table border="1"> <tr> <td>2002-2018</td> <td>2.5</td> <td>L4</td> </tr> <tr> <td>2002-2017</td> <td>3.5</td> <td>V6</td> </tr> <tr> <td>-</td> <td>-</td> <td>-</td> </tr> <tr> <td>-</td> <td>-</td> <td>-</td> </tr> </table>	2002-2018	2.5	L4	2002-2017	3.5	V6	-	-	-	-	-	-
2002-2018	2.5	L4											
2002-2017	3.5	V6											
-	-	-											
-	-	-											
Equivalencias													
KEM PARTS 140729	-												
Especificaciones													
ENFRIAMIENTO													
TOMCO													

SENSOR IAT	T12211												
	<table border="1"> <tr> <td>1997-2001</td> <td>2.4</td> <td>L4</td> </tr> <tr> <td>-</td> <td>-</td> <td>-</td> </tr> <tr> <td>-</td> <td>-</td> <td>-</td> </tr> <tr> <td>-</td> <td>-</td> <td>-</td> </tr> </table>	1997-2001	2.4	L4	-	-	-	-	-	-	-	-	-
1997-2001	2.4	L4											
-	-	-											
-	-	-											
-	-	-											
Equivalencias													
-	-												
Especificaciones													
CARGA AIRE													
TOMCO													

SENSOR KS	144250												
	<table border="1"> <tr> <td>2007-2018</td> <td>2.5</td> <td>L4</td> </tr> <tr> <td>2007-2018</td> <td>3.5</td> <td>V6</td> </tr> <tr> <td>-</td> <td>-</td> <td>-</td> </tr> <tr> <td>-</td> <td>-</td> <td>-</td> </tr> </table>	2007-2018	2.5	L4	2007-2018	3.5	V6	-	-	-	-	-	-
2007-2018	2.5	L4											
2007-2018	3.5	V6											
-	-	-											
-	-	-											
Equivalencias													
TOMCO T29250	-												
Especificaciones													
2 TERMINALES													
KEMPARTS													

SENSOR KS	T29062												
	<table border="1"> <tr> <td>1993-2001</td> <td>2.4</td> <td>L4</td> </tr> <tr> <td>-</td> <td>-</td> <td>-</td> </tr> <tr> <td>-</td> <td>-</td> <td>-</td> </tr> <tr> <td>-</td> <td>-</td> <td>-</td> </tr> </table>	1993-2001	2.4	L4	-	-	-	-	-	-	-	-	-
1993-2001	2.4	L4											
-	-	-											
-	-	-											
-	-	-											
Equivalencias													
-	-												
Especificaciones													
-													
TOMCO													

SENSOR KS	T29231												
	<table border="1"> <tr> <td>2003-2006</td> <td>2.5</td> <td>L4</td> </tr> <tr> <td>2003-2006</td> <td>3.5</td> <td>V6</td> </tr> <tr> <td>-</td> <td>-</td> <td>-</td> </tr> <tr> <td>-</td> <td>-</td> <td>-</td> </tr> </table>	2003-2006	2.5	L4	2003-2006	3.5	V6	-	-	-	-	-	-
2003-2006	2.5	L4											
2003-2006	3.5	V6											
-	-	-											
-	-	-											
Equivalencias													
-	-												
Especificaciones													
2 TERMINALES													
TOMCO													

SENSOR KS	T29250												
	<table border="1"> <tr> <td>2007-2018</td> <td>2.5</td> <td>L4</td> </tr> <tr> <td>2007-2018</td> <td>3.5</td> <td>V6</td> </tr> <tr> <td>-</td> <td>-</td> <td>-</td> </tr> <tr> <td>-</td> <td>-</td> <td>-</td> </tr> </table>	2007-2018	2.5	L4	2007-2018	3.5	V6	-	-	-	-	-	-
2007-2018	2.5	L4											
2007-2018	3.5	V6											
-	-	-											
-	-	-											
Equivalencias													
KEM PARTS 144250	-												
Especificaciones													
-													
TOMCO													

SENSOR MAF	161901												
	<table border="1"> <tr> <td>2002-2006</td> <td>2.5</td> <td>L4</td> </tr> <tr> <td>2002-2006</td> <td>3.5</td> <td>V6</td> </tr> <tr> <td>-</td> <td>-</td> <td>-</td> </tr> <tr> <td>-</td> <td>-</td> <td>-</td> </tr> </table>	2002-2006	2.5	L4	2002-2006	3.5	V6	-	-	-	-	-	-
2002-2006	2.5	L4											
2002-2006	3.5	V6											
-	-	-											
-	-	-											
Equivalencias													
TOMCO T20967	-												
Especificaciones													
CON RESISTENCIA													
KEMPARTS													



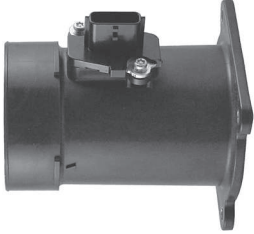

SENSOR MAF	MAF0029
	2004-2007 2.5 L4
	2004-2007 3.5 V6
	- - -
	- - -
Equivalencias	
-	-
Especificaciones	
5 PINES C/CARCASA	
HITACHI	

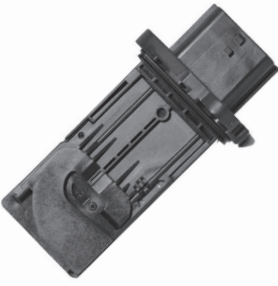
SENSOR MAF	MAF0031
	2003-2015 2.5 L4
	2003-2015 3.5 V6
	- - -
	- - -
Equivalencias	
TOMCO T20965	-
Especificaciones	
5 PINES	
HITACHI	

SENSOR MAF	MAF0102
	2012-2017 2.5 L4
	- - -
	- - -
	- - -
Equivalencias	
-	-
Especificaciones	
5 PINES	
HITACHI	

SENSOR MAF	MAF0123
	2014-2018 2.5 L4
	- - -
	- - -
	- - -
Equivalencias	
-	-
Especificaciones	
4 PINES	
HITACHI	

SENSOR MAF	MAF0133
	2016-2019 2.5 L4
	2016-2019 3.5 V6
	- - -
	- - -
Equivalencias	
-	-
Especificaciones	
5 PINES	
HITACHI	

SENSOR MAF	T20965
	2007-2016 2.5 L4
	2007-2016 3.5 V6
	- - -
	- - -
Equivalencias	
HITACHI MAF0031	-
Especificaciones	
-	
TOMCO	

SENSOR MAF	T20967
	2002-2006 2.5 L4
	2002-2006 3.5 V6
	- - -
	- - -
Equivalencias	
KEM PARTS 161901	-
Especificaciones	
-	
TOMCO	

SENSOR OXÍGENO	138501
	2004-2006 2.5 L4
	2004-2006 3.5 V6
	- - -
	- - -
Equivalencias	
-	-
Especificaciones	
ANTES DEL C.C. SIN CONECTOR 28 CM	
KEMPARTS	



SENSOR OXÍGENO		138660	
	2014-2018	3.5	V6
	-	-	-
	-	-	-
	-	-	-
Equivalencias			
-	-	-	-
Especificaciones			
ANTES DEL CC./ 40 CM			
KEMPARTS			

SENSOR OXÍGENO		138902	
	2007-2010	2.5	L4
	2007-2010	3.5	V6
	-	-	-
	-	-	-
Equivalencias			
TOMCO	-	-	-
T11902	-	-	-
Especificaciones			
ANTES DEL C.C. AIR FUEL RATIO SENSOR 41 CM			
KEMPARTS			

SENSOR OXÍGENO		138908	
	2004-2006	2.5	L4
	2004-2006	3.5	V6
	-	-	-
	-	-	-
Equivalencias			
TOMCO	-	-	-
T11908	-	-	-
Especificaciones			
ANTES DEL C.C. 5 CABLES BANDA ANCHA 46 CM			
KEMPARTS			

SENSOR OXÍGENO		138909	
	2007-2010	2.5	L4
	2007-2012	3.5	V6
	-	-	-
	-	-	-
Equivalencias			
TOMCO	-	-	-
T11909	-	-	-
Especificaciones			
DESPUÉS DEL C.C. 48 CM			
KEMPARTS			

SENSOR OXÍGENO		138957	
	2004-2006	2.5	L4
	2005-2006	3.5	V6
	-	-	-
	-	-	-
Equivalencias			
TOMCO	-	-	-
T11957	-	-	-
Especificaciones			
DESPUÉS DEL C.C. 4 CABLES CON PRECALENTADO 40 CM			
KEMPARTS			

SENSOR OXÍGENO		138959	
	2002-2003	2.5	L4
	-	-	-
	-	-	-
	-	-	-
Equivalencias			
TOMCO	-	-	-
T11959	-	-	-
Especificaciones			
ANTES DEL C.C. 43 CM			
KEMPARTS			

SENSOR OXÍGENO		T11837	
	2011-2013	2.5	L4
	-	-	-
	-	-	-
	-	-	-
Equivalencias			
-	-	-	-
Especificaciones			
TOMCO			

SENSOR OXÍGENO		T11843	
	2015-2015	3.5	V6
	-	-	-
	-	-	-
	-	-	-
Equivalencias			
-	-	-	-
Especificaciones			
D.C.C. 4 CABLES. 40 CM DEL Y TRAS			
TOMCO			



SENSOR OXÍGENO		T11902	
	2007-2010 2.5 L4		
	2007-2010 3.5 V6		
	- - -		
	- - -		
Equivalencias			
KEM PARTS	-		
138902	-		
Especificaciones			
TOMCO			

SENSOR OXÍGENO		T11908	
	2006-2006 2.5 L4		
	2006-2006 3.5 V6		
	- - -		
	- - -		
Equivalencias			
KEM PARTS	-		
138908	-		
Especificaciones			
		ANTES DEL C.C	
TOMCO			

SENSOR OXÍGENO		T11909	
	2007-2010 2.5 L4		
	2007-2012 3.5 V6		
	- - -		
	- - -		
Equivalencias			
KEM PARTS	-		
138909	-		
Especificaciones			
TOMCO			

SENSOR OXÍGENO		T11957	
	2004-2006 2.5 L4		
	2005-2006 3.5 V6		
	- - -		
	- - -		
Equivalencias			
KEM PARTS	-		
138957	-		
Especificaciones			
		DESPUÉS DEL C.C. 4 CABLES CON PRECALENTADO 40 CM	
TOMCO			

SENSOR OXÍGENO		T11959	
	2002-2003 2.5 L4		
	2002-2004 3.5 V6		
	- - -		
	- - -		
Equivalencias			
KEM PARTS	-		
138959	-		
Especificaciones			
TOMCO			

SENSOR POSICIÓN		1477128	
	2002-2006 2.5 L4		
	2002-2006 3.5 V6		
	- - -		
	- - -		
Equivalencias			
-	-		
-	-		
Especificaciones			
		POSICIÓN EN EL CIGÜEÑAL CKP Y ÁRBOL DE LEVAS CMP	
KEMPARTS			

SENSOR TEMPERATURA MOTOR		T12807	
	1996-2001 2.4 L4		
	- - -		
	- - -		
	- - -		
Equivalencias			
KEM PARTS	-		
TW197	-		
Especificaciones			
		TABLERO	
TOMCO			

SENSOR TEMPERATURA MOTOR		TW197	
	1996-2001 2.4 L4		
	- - -		
	- - -		
	- - -		
Equivalencias			
TOMCO	-		
T12807	-		
Especificaciones			
KEMPARTS			



SENSOR TPS	141997												
	<table border="1"> <tr> <td>1996-1997</td> <td>2.4</td> <td>L4</td> </tr> <tr> <td>-</td> <td>-</td> <td>-</td> </tr> <tr> <td>-</td> <td>-</td> <td>-</td> </tr> <tr> <td>-</td> <td>-</td> <td>-</td> </tr> </table>	1996-1997	2.4	L4	-	-	-	-	-	-	-	-	-
1996-1997	2.4	L4											
-	-	-											
-	-	-											
-	-	-											
Equivalencias													
TOMCO T14994	-												
Especificaciones													
TM GIRA HACIA LA IZQUIERDA													
KEMPARTS													

SENSOR TPS	T14994												
	<table border="1"> <tr> <td>1996-1997</td> <td>2.4</td> <td>L4</td> </tr> <tr> <td>-</td> <td>-</td> <td>-</td> </tr> <tr> <td>-</td> <td>-</td> <td>-</td> </tr> <tr> <td>-</td> <td>-</td> <td>-</td> </tr> </table>	1996-1997	2.4	L4	-	-	-	-	-	-	-	-	-
1996-1997	2.4	L4											
-	-	-											
-	-	-											
-	-	-											
Equivalencias													
KEM PARTS 141997	-												
Especificaciones													
-													
TOMCO													

SENSOR VSS	T31134												
	<table border="1"> <tr> <td>2007-2017</td> <td>2.5</td> <td>L4</td> </tr> <tr> <td>2007-2017</td> <td>3.5</td> <td>V6</td> </tr> <tr> <td>-</td> <td>-</td> <td>-</td> </tr> <tr> <td>-</td> <td>-</td> <td>-</td> </tr> </table>	2007-2017	2.5	L4	2007-2017	3.5	V6	-	-	-	-	-	-
2007-2017	2.5	L4											
2007-2017	3.5	V6											
-	-	-											
-	-	-											
Equivalencias													
-	-												
Especificaciones													
-													
TOMCO													

SENSOR VSS	T31151												
	<table border="1"> <tr> <td>2007-2013</td> <td>2.5</td> <td>L4</td> </tr> <tr> <td>-</td> <td>-</td> <td>-</td> </tr> <tr> <td>-</td> <td>-</td> <td>-</td> </tr> <tr> <td>-</td> <td>-</td> <td>-</td> </tr> </table>	2007-2013	2.5	L4	-	-	-	-	-	-	-	-	-
2007-2013	2.5	L4											
-	-	-											
-	-	-											
-	-	-											
Equivalencias													
-	-												
Especificaciones													
ENTRADA SALIDA TRANS C/ 3 TERMINALES CONECTOR RECTO													
TOMCO													

SENSOR VSS	T31168												
	<table border="1"> <tr> <td>2002-2006</td> <td>2.5</td> <td>L4</td> </tr> <tr> <td>2002-2006</td> <td>3.5</td> <td>V6</td> </tr> <tr> <td>-</td> <td>-</td> <td>-</td> </tr> <tr> <td>-</td> <td>-</td> <td>-</td> </tr> </table>	2002-2006	2.5	L4	2002-2006	3.5	V6	-	-	-	-	-	-
2002-2006	2.5	L4											
2002-2006	3.5	V6											
-	-	-											
-	-	-											
Equivalencias													
-	-												
Especificaciones													
3 TERMINALES													
TOMCO													

VÁLVULA VVT	190009												
	<table border="1"> <tr> <td>2002-2005</td> <td>3.5</td> <td>V6</td> </tr> <tr> <td>-</td> <td>-</td> <td>-</td> </tr> <tr> <td>-</td> <td>-</td> <td>-</td> </tr> <tr> <td>-</td> <td>-</td> <td>-</td> </tr> </table>	2002-2005	3.5	V6	-	-	-	-	-	-	-	-	-
2002-2005	3.5	V6											
-	-	-											
-	-	-											
-	-	-											
Equivalencias													
-	-												
Especificaciones													
LADO DERECHO													
KEMPARTS													

VÁLVULA VVT	190010												
	<table border="1"> <tr> <td>2002-2005</td> <td>3.5</td> <td>V6</td> </tr> <tr> <td>-</td> <td>-</td> <td>-</td> </tr> <tr> <td>-</td> <td>-</td> <td>-</td> </tr> <tr> <td>-</td> <td>-</td> <td>-</td> </tr> </table>	2002-2005	3.5	V6	-	-	-	-	-	-	-	-	-
2002-2005	3.5	V6											
-	-	-											
-	-	-											
-	-	-											
Equivalencias													
-	-												
Especificaciones													
2 TERMINALES/ LADO IZQUIERDO													
KEMPARTS													

VÁLVULA VVT	190027												
	<table border="1"> <tr> <td>2002-2006</td> <td>2.5</td> <td>L4</td> </tr> <tr> <td>2007-2014</td> <td>3.5</td> <td>V6</td> </tr> <tr> <td>-</td> <td>-</td> <td>-</td> </tr> <tr> <td>-</td> <td>-</td> <td>-</td> </tr> </table>	2002-2006	2.5	L4	2007-2014	3.5	V6	-	-	-	-	-	-
2002-2006	2.5	L4											
2007-2014	3.5	V6											
-	-	-											
-	-	-											
Equivalencias													
-	-												
Especificaciones													
-													
KEMPARTS													



VÁLVULA VVT	190069
	2007-2012 2.5 L4
	- - -
	- - -
	- - -
Equivalencias	
-	
Especificaciones	
2 TERMINALES	
KEMPARTS	

VÁLVULA VVT	190073
	2014-2017 3.5 V6
	- - -
	- - -
	- - -
Equivalencias	
-	
Especificaciones	
-	
KEMPARTS	

VÁLVULA VVT	190074
	2013-2018 2.5 L4
	- - -
	- - -
	- - -
Equivalencias	
-	
Especificaciones	
2 TERMINALES	
KEMPARTS	

ENFRIAMIENTO

BANDA MICRO V	K040305
	2002-2012 3.5 V6
	- - -
	- - -
	- - -
Equivalencias	
-	
Especificaciones	
DIRECCIÓN ASISTIDA	

BANDA MICRO V	K040335
	1993-1997 2.4 L4
	- - -
	- - -
	- - -
Equivalencias	
-	
Especificaciones	
AAC	

BANDA MICRO V	K040338
	1998-2001 2.4 L4
	- - -
	- - -
	- - -
Equivalencias	
-	
Especificaciones	
AAC	

BANDA MICRO V	K060423
	2002-2012 3.5 V6
	- - -
	- - -
	- - -
Equivalencias	
-	
Especificaciones	
PRINCIPAL	



BANDA MICRO V		K060512	
	2019-2024	2.5	L4
	-	-	-
	-	-	-
	-	-	-
Equivalencias			
-		-	
Especificaciones			
-			

BANDA MICRO V		K060523	
	1993-2001	2.4	L4
	-	-	-
	-	-	-
	-	-	-
Equivalencias			
-		-	
Especificaciones			
OPCIONAL			

BANDA MICRO V		K060525	
	1993-2001	2.4	L4
	-	-	-
	-	-	-
	-	-	-
Equivalencias			
-		-	
Especificaciones			
PRINCIPAL			

BANDA MICRO V		K060563A	
	2013-2018	2.5	L4
	-	-	-
	-	-	-
	-	-	-
Equivalencias			
-		-	
Especificaciones			
-			

BANDA MICRO V		K060880A	
	2007-2017	2.5	L4
	-	-	-
	-	-	-
	-	-	-
Equivalencias			
-		-	
Especificaciones			
-			

BANDA MICRO V		K060885	
	2002-2006	2.5	L4
	-	-	-
	-	-	-
	-	-	-
Equivalencias			
-		-	
Especificaciones			
-			

BANDA MICRO V		K070407	
	2013-2018	3.5	V6
	-	-	-
	-	-	-
	-	-	-
Equivalencias			
-		-	
Especificaciones			
-			

BANDA MICRO V		K070669	
	2007-2012	3.5	V6
	-	-	-
	-	-	-
	-	-	-
Equivalencias			
-		-	
Especificaciones			
-			



BOMBA AGUA		A11212	
	2002-2013	2.5	L4
	-	-	-
	-	-	-
	-	-	-
	-	-	-
Equivalencias			
-	-	-	-
Especificaciones			
-			
HITACHI			

BOMBA AGUA		A11222	
	2007-2018	3.5	V6
	-	-	-
	-	-	-
	-	-	-
	-	-	-
Equivalencias			
MORESA	-	-	-
MBA209020	-	-	-
Especificaciones			
-			
HITACHI			

BOMBA AGUA		MBA209020	
	2007-2018	3.5	V6
	-	-	-
	-	-	-
	-	-	-
	-	-	-
Equivalencias			
HITACHI	-	-	-
A11222	-	-	-
Especificaciones			
-			
MORESA			

BOMBA AGUA		UB2453	
	1993-2001	2.4	L4
	-	-	-
	-	-	-
	-	-	-
	-	-	-
Equivalencias			
SEALED POWER	-	-	-
P2453	-	-	-
Especificaciones			
-			
AUTOPARTES UNICAR			

BOMBA AGUA		UB2440	
	2019-2024	2.5	L4
	-	-	-
	-	-	-
	-	-	-
	-	-	-
Equivalencias			
-	-	-	-
Especificaciones			
-			
AUTOPARTES UNICAR			

BOMBA AGUA		UB2540	
	2013-2018	2.5	L4
	-	-	-
	-	-	-
	-	-	-
	-	-	-
Equivalencias			
MORESA	-	-	-
MBA202625	-	-	-
Especificaciones			
-			
AUTOPARTES UNICAR			

BOMBA AGUA		UB9276	
	2002-2006	3.5	V6
	-	-	-
	-	-	-
	-	-	-
	-	-	-
Equivalencias			
MORESA	SEALED POWER	-	-
MBA209426	P9276	-	-
Especificaciones			
-			
AUTOPARTES UNICAR			

BOMBA AGUA		UB9427	
	2002-2013	2.5	L4
	-	-	-
	-	-	-
	-	-	-
	-	-	-
Equivalencias			
MORESA	SEALED POWER	-	-
MBA209427	P9427	-	-
Especificaciones			
-			
AUTOPARTES UNICAR			



MANGUERA RADIADOR	CH22963												
	<table border="1"> <tr> <td>2002-2006</td> <td>3.5</td> <td>V6</td> </tr> <tr> <td>-</td> <td>-</td> <td>-</td> </tr> <tr> <td>-</td> <td>-</td> <td>-</td> </tr> <tr> <td>-</td> <td>-</td> <td>-</td> </tr> </table>	2002-2006	3.5	V6	-	-	-	-	-	-	-	-	-
2002-2006	3.5	V6											
-	-	-											
-	-	-											
-	-	-											
Equivalencias													
-	-												
Especificaciones													
SUPERIOR													

MANGUERA RADIADOR	CH22965												
	<table border="1"> <tr> <td>2002-2006</td> <td>2.5</td> <td>L4</td> </tr> <tr> <td>-</td> <td>-</td> <td>-</td> </tr> <tr> <td>-</td> <td>-</td> <td>-</td> </tr> <tr> <td>-</td> <td>-</td> <td>-</td> </tr> </table>	2002-2006	2.5	L4	-	-	-	-	-	-	-	-	-
2002-2006	2.5	L4											
-	-	-											
-	-	-											
-	-	-											
Equivalencias													
-	-												
Especificaciones													
SUPERIOR													

MANGUERA RADIADOR	CH23350												
	<table border="1"> <tr> <td>2007-2018</td> <td>3.5</td> <td>V6</td> </tr> <tr> <td>-</td> <td>-</td> <td>-</td> </tr> <tr> <td>-</td> <td>-</td> <td>-</td> </tr> <tr> <td>-</td> <td>-</td> <td>-</td> </tr> </table>	2007-2018	3.5	V6	-	-	-	-	-	-	-	-	-
2007-2018	3.5	V6											
-	-	-											
-	-	-											
-	-	-											
Equivalencias													
GATES 23350	-												
Especificaciones													
SUPERIOR TOMA A MOTOR													

MANGUERA RADIADOR	CH20795												
	<table border="1"> <tr> <td>1993-2001</td> <td>2.4</td> <td>L4</td> </tr> <tr> <td>-</td> <td>-</td> <td>-</td> </tr> <tr> <td>-</td> <td>-</td> <td>-</td> </tr> <tr> <td>-</td> <td>-</td> <td>-</td> </tr> </table>	1993-2001	2.4	L4	-	-	-	-	-	-	-	-	-
1993-2001	2.4	L4											
-	-	-											
-	-	-											
-	-	-											
Equivalencias													
-	-												
Especificaciones													
INFERIOR													

MANGUERA RADIADOR	CH221271												
	<table border="1"> <tr> <td>1993-2001</td> <td>2.4</td> <td>L4</td> </tr> <tr> <td>-</td> <td>-</td> <td>-</td> </tr> <tr> <td>-</td> <td>-</td> <td>-</td> </tr> <tr> <td>-</td> <td>-</td> <td>-</td> </tr> </table>	1993-2001	2.4	L4	-	-	-	-	-	-	-	-	-
1993-2001	2.4	L4											
-	-	-											
-	-	-											
-	-	-											
Equivalencias													
-	-												
Especificaciones													
INFERIOR													

MANGUERA RADIADOR	CH22966												
	<table border="1"> <tr> <td>2002-2006</td> <td>2.5</td> <td>L4</td> </tr> <tr> <td>-</td> <td>-</td> <td>-</td> </tr> <tr> <td>-</td> <td>-</td> <td>-</td> </tr> <tr> <td>-</td> <td>-</td> <td>-</td> </tr> </table>	2002-2006	2.5	L4	-	-	-	-	-	-	-	-	-
2002-2006	2.5	L4											
-	-	-											
-	-	-											
-	-	-											
Equivalencias													
-	-												
Especificaciones													
INFERIOR													

POLEA LOCA	36087												
	<table border="1"> <tr> <td>1994-2006</td> <td>3.5</td> <td>V6</td> </tr> <tr> <td>-</td> <td>-</td> <td>-</td> </tr> <tr> <td>-</td> <td>-</td> <td>-</td> </tr> <tr> <td>-</td> <td>-</td> <td>-</td> </tr> </table>	1994-2006	3.5	V6	-	-	-	-	-	-	-	-	-
1994-2006	3.5	V6											
-	-	-											
-	-	-											
-	-	-											
Equivalencias													
-	-												
Especificaciones													
-													

POLEA LOCA	U111161												
	<table border="1"> <tr> <td>2013-2018</td> <td>3.5</td> <td>V6</td> </tr> <tr> <td>-</td> <td>-</td> <td>-</td> </tr> <tr> <td>-</td> <td>-</td> <td>-</td> </tr> <tr> <td>-</td> <td>-</td> <td>-</td> </tr> </table>	2013-2018	3.5	V6	-	-	-	-	-	-	-	-	-
2013-2018	3.5	V6											
-	-	-											
-	-	-											
-	-	-											
Equivalencias													
-	-												
Especificaciones													
LISA 70X34 MM													



POLEA LOCA	U131136
	1998-2001 2.4 L4
	- - -
	- - -
	- - -
Equivalencias	
-	-
Especificaciones	
AAC	

POLEA LOCA	U138311
	1993-1997 2.4 L4
	- - -
	- - -
	- - -
Equivalencias	
-	-
Especificaciones	
AAC	

RADIADOR	RA1450
	2007-2018 2.5 L4
	2007-2018 3.5 V6
	- - -
	- - -
Equivalencias	
-	-
Especificaciones	
T/A CON A/C	

RADIADOR	RA5843
	2002-2006 2.5 L4
	- - -
	- - -
	- - -
Equivalencias	
-	-
Especificaciones	
T/A	

TAPÓN RADIADOR	31533
	2002-2006 2.5 L4
	2002-2006 3.5 L4
	1993-2001 2.4 L4
	- - -
Equivalencias	
-	-
Especificaciones	
13 PSI C/VÁLVULA DE SEGURIDAD	

TAPÓN RADIADOR	UTR13R
	2002-2006 2.5 L4
	2002-2006 3.5 L4
	1993-2001 2.4 L4
	- - -
Equivalencias	
GATES 31333	-
Especificaciones	
13 PSI	

TAPÓN RADIADOR	UTR20R
	2019-2024 2.0 TURBO L4
	2007-2024 2.5 L4
	2007-2018 3.5 V6
	- - -
Equivalencias	
GATES 31564	-
Especificaciones	
20 PSI	

TENSOR BANDA ACCESORIOS	U90720
	2013-2018 2.5 L4
	- - -
	- - -
	- - -
Equivalencias	
-	-
Especificaciones	

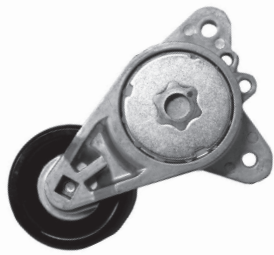

TENSOR BANDA ACCESORIOS		U90722	
	2013-2018	3.5	V6
	-	-	-
	-	-	-
	-	-	-
Equivalencias		-	-
Especificaciones		-	-





TENSOR BANDA ACCESORIOS		UKR90322	
	2002-2013	2.5	L4
	-	-	-
	-	-	-
	-	-	-
Equivalencias		GATES 38284	-
Especificaciones		-	-



TERMOSTATO		U2028170	
	1993-2001	2.4	L4
	-	-	-
	-	-	-
	-	-	-
Equivalencias		GATES 33747	KEM 2028170
Especificaciones		TEMP ORIGINAL 77C	





TERMOSTATO		U427180	
	2002-2018	2.5	L4
	-	-	-
	-	-	-
	-	-	-
Equivalencias		GATES 33941	-
Especificaciones		82C	





TERMOSTATO		U427457	
	2002-2024	2.5	L4
	-	-	-
	-	-	-
	-	-	-
Equivalencias		-	-
Especificaciones		JUEGO DE 2 TERMOSTATOS 83C/96C	



TERMOSTATO		U457205	
	2002-2013	2.5	L4
	-	-	-
	-	-	-
	-	-	-
Equivalencias		GATES 34160	-
Especificaciones		96C LATERAL	



TERMOSTATO		U647180	
	2019-2024	2.5	L4
	-	-	-
	-	-	-
	-	-	-
Equivalencias		GATES 34162	-
Especificaciones		83C	



TOMA AGUA		UTA21503	
	2013-2018	2.5	L4
	2013-2018	3.5	V6
	-	-	-
	-	-	-
Equivalencias		-	-
Especificaciones		CUELLO DE LLENADO	





TOMA AGUA	UTA21506
	2019-2024 2.5 L4
	- - -
	- - -
	- - -
	- - -
Equivalencias	
-	
Especificaciones	
CUELLO DE LLENADO	
	

TOMA AGUA	UTA409326
	2007-2018 2.5 L4
	- - -
	- - -
	- - -
	- - -
Equivalencias	
-	
Especificaciones	
-	
	

TOMA AGUA	UTA409327
	2019-2024 2.5 L4
	- - -
	- - -
	- - -
	- - -
Equivalencias	
-	
Especificaciones	
-	
	

TOMA AGUA	UTA409400T
	2010-2018 3.5 V6
	- - -
	- - -
	- - -
	- - -
Equivalencias	
-	
Especificaciones	
C/TERMOSTATO	
	

TOMA AGUA	UTA419
	2007-2012 3.5 V6
	- - -
	- - -
	- - -
	- - -
Equivalencias	
-	
Especificaciones	
CUELLO DE LLENADO	
	

FRENOS



BALATA DISCO	M7318Z2D815
	2013-2014 2.5 L4
	2008-2014 3.5 V6
	- - -
	- - -
	- - -
Equivalencias	
WAGNER	-
WX815	-
Especificaciones	
DELANTERO SEMI-METALICA	
	

BALATA DISCO	M7318ZD430
	1996-1996 2.4 L4
	- - -
	- - -
	- - -
	- - -
Equivalencias	
WAGNER	-
WX430	-
Especificaciones	
DELANTERO SEMI-METALICA	
	



Mayoreo en autopartes

BALATA DISCO	M7533ZD540
	1996-1996 2.4 L4
	- - -
	- - -
	- - -
Equivalencias	
-	-
Especificaciones	
TRASERO SEMI-METALICA	

BALATA DISCO	M7783ZD815
	2008-2009 3.5 V6
	- - -
	- - -
	- - -
Equivalencias	
-	-
Especificaciones	
DELANTERO SEMI-METALICA	

BALATA DISCO	M8405ZD1288
	2008-2009 3.5 V6
	- - -
	- - -
	- - -
Equivalencias	
-	-
Especificaciones	
TRASERO SEMI-METALICA	

BALATA DISCO	OEX1288
	2007-2010 - -
	- - -
	- - -
	- - -
Equivalencias	
-	-
Especificaciones	
TRASERO CERÁMICA HERRAJE PARA INSTALACIÓN INCLUIDO	

BALATA DISCO	OEX969
	2005-2006 - -
	- - -
	- - -
	- - -
Equivalencias	
-	-
Especificaciones	
DELANTERO CERÁMICA HERRAJE PARA INSTALACIÓN INCLUIDO	

BALATA DISCO	SPC7318ZD815
	2013-2014 2.5 L4
	2008-2014 3.5 V6
	- - -
	- - -
Equivalencias	
WAGNER	-
WC815A	-
Especificaciones	
DELANTERO CERÁMICA	

BALATA DISCO	SPC7318ZD430
	1996-1996 2.4 L4
	- - -
	- - -
	- - -
Equivalencias	
WAGNER	-
WD430	-
Especificaciones	
DELANTERO CERÁMICA	

BALATA DISCO	SPC7533ZD540
	1996-1996 2.4 L4
	- - -
	- - -
	- - -
Equivalencias	
-	-
Especificaciones	
TRASERO CERÁMICA	



BALATA DISCO	SPC7783ZD815
	2008-2009 3.5 V6
	- - -
	- - -
	- - -
Equivalencias	
-	-
Especificaciones	
DELANTERO CERÁMICA	

BALATA DISCO	SPC8405ZD1288
	2008-2009 3.5 V6
	- - -
	- - -
	- - -
Equivalencias	
-	-
Especificaciones	
TRASERO CERÁMICA	

BALATA DISCO	SPC8501ZD1393
	2013-2019 2.5 L4
	2019-2019 2.0 L4
	2013-2017 3.5 V6
	- - -
Equivalencias	
WAGNER WC1393	-
Especificaciones	
TRASERO CERÁMICA	

BALATA DISCO	SPC8878ZD1650
	2011-2018 2.5 L4
	2019-2019 2.0 L4
	2009-2018 3.5 V6
	- - -
Equivalencias	
WAGNER WC1650	-
Especificaciones	
DELANTERO CERÁMICA	

BALATA DISCO	SPC7784ZD905
	2002-2006 2.5 L4
	- - -
	- - -
	- - -
Equivalencias	
WAGNER WD905	-
Especificaciones	
TRASERO CERÁMICA	

CHICOTE FRENO	NI669
	2006-2006 2.5 L4
	2006-2006 3.5 V6
	- - -
	- - -
Equivalencias	
-	-
Especificaciones	
TRAS DER	

CHICOTE FRENO	NI670
	2006-2006 2.5 L4
	2006-2006 3.5 V6
	- - -
	- - -
Equivalencias	
-	-
Especificaciones	
TRAS IZQ	

CILINDRO MAESTRO	U390140L
	1996-2001 2.4 L4
	- - -
	- - -
	- - -
Equivalencias	
-	-
Especificaciones	
15/16 PULG	



Mayoreo en autopartes

CILINDRO MAESTRO	U390800L												
	<table border="1"> <tr> <td>2002-2006</td> <td>2.4</td> <td>L4</td> </tr> <tr> <td>-</td> <td>-</td> <td>-</td> </tr> <tr> <td>-</td> <td>-</td> <td>-</td> </tr> <tr> <td>-</td> <td>-</td> <td>-</td> </tr> </table>	2002-2006	2.4	L4	-	-	-	-	-	-	-	-	-
2002-2006	2.4	L4											
-	-	-											
-	-	-											
-	-	-											
Equivalencias													
-													
Especificaciones													
15/16 PULG													

CILINDRO MAESTRO	U460106CA0A												
	<table border="1"> <tr> <td>2019-2025</td> <td>2.5</td> <td>L4</td> </tr> <tr> <td>-</td> <td>-</td> <td>-</td> </tr> <tr> <td>-</td> <td>-</td> <td>-</td> </tr> <tr> <td>-</td> <td>-</td> <td>-</td> </tr> </table>	2019-2025	2.5	L4	-	-	-	-	-	-	-	-	-
2019-2025	2.5	L4											
-	-	-											
-	-	-											
-	-	-											
Equivalencias													
-													
Especificaciones													
-													

CILINDRO RUEDA	U441000Z40L												
	<table border="1"> <tr> <td>1996-2001</td> <td>2.4</td> <td>L4</td> </tr> <tr> <td>-</td> <td>-</td> <td>-</td> </tr> <tr> <td>-</td> <td>-</td> <td>-</td> </tr> <tr> <td>-</td> <td>-</td> <td>-</td> </tr> </table>	1996-2001	2.4	L4	-	-	-	-	-	-	-	-	-
1996-2001	2.4	L4											
-	-	-											
-	-	-											
-	-	-											
Equivalencias													
-													
Especificaciones													
15/16 PULG													

DISCO	FR20027												
	<table border="1"> <tr> <td>1993-2001</td> <td>2.4</td> <td>L4</td> </tr> <tr> <td>-</td> <td>-</td> <td>-</td> </tr> <tr> <td>-</td> <td>-</td> <td>-</td> </tr> <tr> <td>-</td> <td>-</td> <td>-</td> </tr> </table>	1993-2001	2.4	L4	-	-	-	-	-	-	-	-	-
1993-2001	2.4	L4											
-	-	-											
-	-	-											
-	-	-											
Equivalencias													
-													
Especificaciones													
DELANTERO VENTILADO 4 BIRLOS O BARRENOS													

DISCO	FR20034												
	<table border="1"> <tr> <td>2013-2019</td> <td>2.5</td> <td>L4</td> </tr> <tr> <td>2019-2019</td> <td>2.0</td> <td>L4</td> </tr> <tr> <td>2008-2018</td> <td>3.5</td> <td>V6</td> </tr> <tr> <td>-</td> <td>-</td> <td>-</td> </tr> </table>	2013-2019	2.5	L4	2019-2019	2.0	L4	2008-2018	3.5	V6	-	-	-
2013-2019	2.5	L4											
2019-2019	2.0	L4											
2008-2018	3.5	V6											
-	-	-											
Equivalencias													
-													
Especificaciones													
TRASERO SOLIDO 5 BIRLOS O BARRENOS													

DISCO	FR20038												
	<table border="1"> <tr> <td>2006-2006</td> <td>2.5</td> <td>L4</td> </tr> <tr> <td>2006-2006</td> <td>3.5</td> <td>V6</td> </tr> <tr> <td>-</td> <td>-</td> <td>-</td> </tr> <tr> <td>-</td> <td>-</td> <td>-</td> </tr> </table>	2006-2006	2.5	L4	2006-2006	3.5	V6	-	-	-	-	-	-
2006-2006	2.5	L4											
2006-2006	3.5	V6											
-	-	-											
-	-	-											
Equivalencias													
-													
Especificaciones													
VENTILADO 5 BARRENOS DELANTERO													

DISCO	FR20054												
	<table border="1"> <tr> <td>2007-2012</td> <td>3.5</td> <td>V6</td> </tr> <tr> <td>-</td> <td>-</td> <td>-</td> </tr> <tr> <td>-</td> <td>-</td> <td>-</td> </tr> <tr> <td>-</td> <td>-</td> <td>-</td> </tr> </table>	2007-2012	3.5	V6	-	-	-	-	-	-	-	-	-
2007-2012	3.5	V6											
-	-	-											
-	-	-											
-	-	-											
Equivalencias													
-													
Especificaciones													
DELANTERO VENTILADO 5 BIRLOS O BARRENOS													

DISCO	FR20068												
	<table border="1"> <tr> <td>2013-2019</td> <td>2.5</td> <td>L4</td> </tr> <tr> <td>2019-2019</td> <td>2.0</td> <td>L4</td> </tr> <tr> <td>2013-2018</td> <td>3.5</td> <td>V6</td> </tr> <tr> <td>-</td> <td>-</td> <td>-</td> </tr> </table>	2013-2019	2.5	L4	2019-2019	2.0	L4	2013-2018	3.5	V6	-	-	-
2013-2019	2.5	L4											
2019-2019	2.0	L4											
2013-2018	3.5	V6											
-	-	-											
Equivalencias													
-													
Especificaciones													
DELANTERO VENTILADO 5 BIRLOS O BARRENOS													



KIT CALIPER	UKC40142
	2012-2013 - - -
	- - - -
	- - - -
	- - - -
Equivalencias	
-	
Especificaciones	
DEL D815	

KIT CALIPER	UKC508
	2002-2013 2.5 L4
	- - - -
	- - - -
	- - - -
Equivalencias	
-	
Especificaciones	
DEL D815	

KIT CALIPER	UKC509
	2002-2015 - - -
	- - - -
	- - - -
	- - - -
Equivalencias	
-	
Especificaciones	
TRASD95	

KIT CALIPER	UKC519
	2015-2017 - - -
	- - - -
	- - - -
	- - - -
Equivalencias	
-	
Especificaciones	
TRASD95.D1288.D1393	

KIT CALIPER	UKC538
	2015-2017 - - -
	- - - -
	- - - -
	- - - -
Equivalencias	
-	
Especificaciones	
DELBAL 8878D165	

KIT TAMBOR	UKT416
	2013-2017 - - -
	- - - -
	- - - -
	- - - -
Equivalencias	
-	
Especificaciones	
FRENO ESTACIONAMIENTO BALATA 1592 869. 1591 867	

MOTOR

ANILLOS	3200KX030
	2000-2004 2.5 L4
	- - - -
	- - - -
	- - - -
Equivalencias	
MELLING M2C5099030	
Especificaciones	
Ø89. RANURAS 1.28 2.54 16 VÁLVULAS DOHC CROMADO	



ANILLOS	3200KXSTD
	2000-2004 2.5 L4
	- - -
	- - -
	- - -
Equivalencias	
MELLING	-
M2C5099STD	-
Especificaciones	
Ø89. RANURAS 1.28 2.54 16 VÁLVULAS DOHC CROMADO	
MAHLE	

ANILLOS	42239CP010
	2002-2006 3.5 V6
	- - -
	- - -
	- - -
Equivalencias	
-	-
-	-
Especificaciones	
-	
MAHLE	

ANILLOS	42239CP020
	2002-2006 3.5 V6
	- - -
	- - -
	- - -
Equivalencias	
MORESA	MELLING
MAP5112C020	M2C5112020
Especificaciones	
-	
MAHLE	

ANILLOS	42239CP030
	2002-2006 3.5 V6
	- - -
	- - -
	- - -
Equivalencias	
MORESA	-
MAP5112C030	-
Especificaciones	
-	
MAHLE	

ANILLOS	42239CPSTD
	2006-2007 3.5 V6
	- - -
	- - -
	- - -
Equivalencias	
MORESA	MELLING
MAP5112CSTD	M2C5112STD
Especificaciones	
Ø95.5 RANURAS 1.212 2.56 CROMADO	
MAHLE	

ANILLOS	42285CP020
	2002-2006 2.5 L4
	- - -
	- - -
	- - -
Equivalencias	
-	-
-	-
Especificaciones	
1.20 MM 1.20 MM 2.50 MM	
MAHLE	

ANILLOS	42285CPSTD
	2002-2006 2.5 L4
	- - -
	- - -
	- - -
Equivalencias	
-	-
-	-
Especificaciones	
1.20 MM 1.20 MM 2.50 MM	
MAHLE	

ANILLOS	M2C4516020
	2007-2010 2.5 L4
	- - -
	- - -
	- - -
Equivalencias	
-	-
-	-
Especificaciones	
Ø89. RANURAS 1.24 1.22 2.4 CROMADO	
MELLING ENGINE PARTS	



ANILLOS	M2C4516030
	2007-2010 2.5 L4
	- - -
	- - -
	- - -
Equivalencias	
-	-
Especificaciones	
Ø89. RANURAS 1.24 1.22 2.4 CROMADO	

ANILLOS	MAP5099C020
	1993-2001 2.4 L4
	2007-2013 2.5 L4
	- - -
	- - -
Equivalencias	
MELLING	-
M2C5099020	-
Especificaciones	
MATERIAL: CROMADO ESP. 1ER ANILLO: 47.0 PULG ESP. 2DO ANILLO: 47.0 PULG ESP. ANILLO ACEITE: 98.0 PULG	

ANILLOS	MAP5099C030
	1993-2001 2.4 L4
	2007-2013 2.5 L4
	- - -
	- - -
Equivalencias	
-	-
Especificaciones	
MATERIAL: CROMADO ESP. 1ER ANILLO: 47.0 PULG ESP. 2DO ANILLO: 47.0 PULG ESP. ANILLO ACEITE: 98.0 PULG	

ANILLOS	MAP5099CSTD
	1993-2001 2.4 L4
	2007-2013 2.5 L4
	- - -
	- - -
Equivalencias	
-	-
Especificaciones	
MATERIAL: CROMADO ESP. 1ER ANILLO: 47.0 PULG ESP. 2DO ANILLO: 47.0 PULG ESP. ANILLO ACEITE: 98.0 PULG	

BOMBA ACEITE	B21205
	1993-2004 2.4 L4
	- - -
	- - -
	- - -
Equivalencias	
-	-
Especificaciones	
1 RESORTE	

BOMBA ACEITE	B21211
	2006-2007 3.5 V6
	- - -
	- - -
	- - -
Equivalencias	
-	-
Especificaciones	

BOMBA ACEITE	B21217
	2007-2013 2.5 L4
	- - -
	- - -
	- - -
Equivalencias	
-	-
Especificaciones	

BOMBA ACEITE	B21226
	2015-2017 3.5 V6
	- - -
	- - -
	- - -
Equivalencias	
-	-
Especificaciones	



BOMBA ACEITE	MA309
	1993-2001 2.4 L4
	- - -
	- - -
	- - -
Equivalencias	
-	-
Especificaciones	
-	

MELLING
ENGINE PARTS

BOMBA ACEITE	MA152
	1993-1993 2.4 L4
	- - -
	- - -
	- - -
Equivalencias	
MELLING M152	-
Especificaciones	
16V	

BOMBA ACEITE	MA21212
	2006-2006 2.5 L4
	- - -
	- - -
	- - -
Equivalencias	
MELLING 6515	-
Especificaciones	
-	

BOMBA ACEITE	MA21221
	2007-2013 2.5 L4
	- - -
	- - -
	- - -
Equivalencias	
REXITE RMA318	-
Especificaciones	
-	

BOMBA ACEITE	MA21224
	2013-2016 2.5 L4
	- - -
	- - -
	- - -
Equivalencias	
HITACHI B21224	-
Especificaciones	
DOHC 16V	

BOMBA ACEITE	RMA309
	1993-2001 2.4 L4
	- - -
	- - -
	- - -
Equivalencias	
-	-
Especificaciones	
16V	

BOMBA ACEITE	RMA313
	2002-2006 2.5 L4
	- - -
	- - -
	- - -
Equivalencias	
HITACHI B21212	-
Especificaciones	
16V	

BOMBA ACEITE	RMA317
	2008-2012 2.5 L4
	- - -
	- - -
	- - -
Equivalencias	
-	-
Especificaciones	
16V	



BOMBA ACEITE	RMA421
	1993-2000 2.4 L4
	- - -
	- - -
	- - -
Equivalencias	
-	-
Especificaciones	
16V	

BOMBA ACEITE	RMA484
	2013-2016 2.5 L4
	- - -
	- - -
	- - -
Equivalencias	
-	-
Especificaciones	
16V	

BUJE BIELA	4BB4105
	1993-2001 2.4 L4
	- - -
	- - -
	- - -
Equivalencias	
-	-
Especificaciones	
16V ANCHO: 0.984 PULG	

MORESA

CAMISA	2268211
	2000-2009 2.4 L4
	2006-2011 2.5 L4
	- - -
	- - -
Equivalencias	
MORESA MC10070	-
Especificaciones	
89MM	

MAHLE

CAMISA	MC10
	1993-2018 2.4 L4
	- - -
	- - -
	- - -
Equivalencias	
-	-
Especificaciones	
DOHC 16	

MORESA

CAMISA	MC14070
	2002-2018 3.5 V6
	- - -
	- - -
	- - -
Equivalencias	
-	-
Especificaciones	

MORESA

GUÍA VÁLVULA	G1115
	1991-1998 2.4 L4
	- - -
	- - -
	- - -
Equivalencias	
-	-
Especificaciones	
ADM/ESC ØINT .275. ØEXT .435. LONG 2.6	

Chromite

JUEGO JUNTAS MOTOR	FS1233
	1993-2001 2.4 L4
	- - -
	- - -
	- - -
Equivalencias	
-	-
Especificaciones	
DOHC	

DC gaskets



JUEGO JUNTAS MOTOR		FS1235GX												
	<table border="1"> <tr> <td>2002-2006</td> <td>2.5</td> <td>L4</td> </tr> <tr> <td>-</td> <td>-</td> <td>-</td> </tr> <tr> <td>-</td> <td>-</td> <td>-</td> </tr> <tr> <td>-</td> <td>-</td> <td>-</td> </tr> </table>	2002-2006	2.5	L4	-	-	-	-	-	-	-	-	-	
2002-2006	2.5	L4												
-	-	-												
-	-	-												
-	-	-												
Equivalencias		-	-											
Especificaciones		DOHC 16V SOBRE MEDIDA 0.020												

JUEGO JUNTAS MOTOR		FS1245G												
	<table border="1"> <tr> <td>2007-2012</td> <td>2.5</td> <td>L4</td> </tr> <tr> <td>-</td> <td>-</td> <td>-</td> </tr> <tr> <td>-</td> <td>-</td> <td>-</td> </tr> <tr> <td>-</td> <td>-</td> <td>-</td> </tr> </table>	2007-2012	2.5	L4	-	-	-	-	-	-	-	-	-	
2007-2012	2.5	L4												
-	-	-												
-	-	-												
-	-	-												
Equivalencias		-	-											
Especificaciones		DOHC QR25DE												

JUEGO JUNTAS MOTOR		FS12651ML												
	<table border="1"> <tr> <td>2013-2016</td> <td>2.5</td> <td>L4</td> </tr> <tr> <td>-</td> <td>-</td> <td>-</td> </tr> <tr> <td>-</td> <td>-</td> <td>-</td> </tr> <tr> <td>-</td> <td>-</td> <td>-</td> </tr> </table>	2013-2016	2.5	L4	-	-	-	-	-	-	-	-	-	
2013-2016	2.5	L4												
-	-	-												
-	-	-												
-	-	-												
Equivalencias		-	-											
Especificaciones		DOHC QR25DE												

JUEGO JUNTAS MOTOR		JC20												
	<table border="1"> <tr> <td>1993-1998</td> <td>2.4</td> <td>L4</td> </tr> <tr> <td>-</td> <td>-</td> <td>-</td> </tr> <tr> <td>-</td> <td>-</td> <td>-</td> </tr> <tr> <td>-</td> <td>-</td> <td>-</td> </tr> </table>	1993-1998	2.4	L4	-	-	-	-	-	-	-	-	-	
1993-1998	2.4	L4												
-	-	-												
-	-	-												
-	-	-												
Equivalencias		-	-											
Especificaciones		16 VÁLVULAS												

JUEGO JUNTAS MOTOR		JC30												
	<table border="1"> <tr> <td>1999-2001</td> <td>2.4</td> <td>L4</td> </tr> <tr> <td>-</td> <td>-</td> <td>-</td> </tr> <tr> <td>-</td> <td>-</td> <td>-</td> </tr> <tr> <td>-</td> <td>-</td> <td>-</td> </tr> </table>	1999-2001	2.4	L4	-	-	-	-	-	-	-	-	-	
1999-2001	2.4	L4												
-	-	-												
-	-	-												
-	-	-												
Equivalencias		-	-											
Especificaciones		16 VÁLVULAS												

JUEGO JUNTAS MOTOR		JC34												
	<table border="1"> <tr> <td>2002-2007</td> <td>2.5</td> <td>L4</td> </tr> <tr> <td>-</td> <td>-</td> <td>-</td> </tr> <tr> <td>-</td> <td>-</td> <td>-</td> </tr> <tr> <td>-</td> <td>-</td> <td>-</td> </tr> </table>	2002-2007	2.5	L4	-	-	-	-	-	-	-	-	-	
2002-2007	2.5	L4												
-	-	-												
-	-	-												
-	-	-												
Equivalencias		DC FS1235G	DC FS1235ML											
Especificaciones		16 VÁLVULAS												

JUEGO JUNTAS MOTOR		JC35												
	<table border="1"> <tr> <td>2002-2018</td> <td>3.5</td> <td>V6</td> </tr> <tr> <td>-</td> <td>-</td> <td>-</td> </tr> <tr> <td>-</td> <td>-</td> <td>-</td> </tr> <tr> <td>-</td> <td>-</td> <td>-</td> </tr> </table>	2002-2018	3.5	V6	-	-	-	-	-	-	-	-	-	
2002-2018	3.5	V6												
-	-	-												
-	-	-												
-	-	-												
Equivalencias		DC FS1236ML	-											
Especificaciones		24 VÁLVULAS												

JUEGO JUNTAS MOTOR		JC36												
	<table border="1"> <tr> <td>2008-2013</td> <td>2.5</td> <td>L4</td> </tr> <tr> <td>-</td> <td>-</td> <td>-</td> </tr> <tr> <td>-</td> <td>-</td> <td>-</td> </tr> <tr> <td>-</td> <td>-</td> <td>-</td> </tr> </table>	2008-2013	2.5	L4	-	-	-	-	-	-	-	-	-	
2008-2013	2.5	L4												
-	-	-												
-	-	-												
-	-	-												
Equivalencias		DC FS1245ML	-											
Especificaciones		16 VÁLVULAS												



JUEGO JUNTAS MOTOR	JC47
	2014-2018 2.5 L4
	- - -
	- - -
	- - -
Equivalencias	
-	
Especificaciones	
16 VÁLVULAS	

JUNTA CABEZA	CA1235GX
	2006-2006 2.5 L4
	- - -
	- - -
	- - -
Equivalencias	
-	
Especificaciones	
DOHC QR25DE SOBREMEDIDA 0.070	

JUNTA CABEZA	CA1245GX
	2007-2012 2.5 L4
	- - -
	- - -
	- - -
Equivalencias	
-	
Especificaciones	
DOHC QR25DE SOBREMEDIDA 0.070	

JUNTA CABEZA	CA20
	1993-1998 2.4 L4
	- - -
	- - -
	- - -
Equivalencias	
-	
Especificaciones	
16 VÁLVULAS	

JUNTA CABEZA	CA30
	1999-2001 2.4 L4
	- - -
	- - -
	- - -
Equivalencias	
-	
Especificaciones	
16 VÁLVULAS	

JUNTA CABEZA	CA33
	1993-2001 2.4 L4
	- - -
	- - -
	- - -
Equivalencias	
DC CA1233G	
Especificaciones	
16 VÁLVULAS	

JUNTA CABEZA	CA34
	2002-2007 2.5 L4
	- - -
	- - -
	- - -
Equivalencias	
DC CA1235G DC CA1235ML	
Especificaciones	
16 VÁLVULAS	

JUNTA CABEZA	CA35D
	2002-2018 3.5 V6
	- - -
	- - -
	- - -
Equivalencias	
DC CA12361ML	
Especificaciones	
24 VÁLVULAS	



JUNTA CABEZA	CA351
 <p>TF VICTOR</p>	2002-2018 3.5 V6
	- - -
	- - -
	- - -
	- - -
Equivalencias	
DC CA1236ML	-
Especificaciones	
24 VÁLVULAS	

JUNTA CABEZA	CA36
 <p>TF VICTOR</p>	2008-2013 2.5 L4
	- - -
	- - -
	- - -
	- - -
Equivalencias	
DC CA1245G	DC CA1245ML
Especificaciones	
16 VÁLVULAS	

JUNTA CABEZA	CA47
 <p>TF VICTOR</p>	2014-2018 2.5 L4
	- - -
	- - -
	- - -
	- - -
Equivalencias	
DC CA12651ML	-
Especificaciones	
16 VÁLVULAS	

JUNTA CARTER	OS11232
 <p>DC gaskets</p>	2000-2001 2.4 L4
	- - -
	- - -
	- - -
	- - -
Equivalencias	
-	-
Especificaciones	
-	

JUNTA CARTER	OS1 1233
 <p>DC gaskets</p>	1993-2001 2.4 L4
	- - -
	- - -
	- - -
	- - -
Equivalencias	
-	-
Especificaciones	
DOHC	

JUNTA CARTER	OS11244
 <p>DC gaskets</p>	2002-2015 3.5 L6
	- - -
	- - -
	- - -
	- - -
Equivalencias	
-	-
Especificaciones	
DOHC	

JUNTA CARTER	CJ120
 <p>TF VICTOR</p>	1993-1998 2.4 L4
	- - -
	- - -
	- - -
	- - -
Equivalencias	
-	-
Especificaciones	
16 VÁLVULAS	

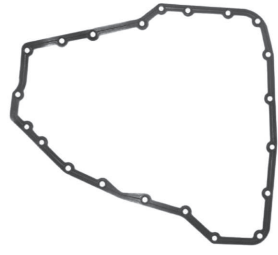
JUNTA CARTER	CJ134
 <p>TF VICTOR</p>	2002-2007 2.5 L4
	- - -
	- - -
	- - -
	- - -
Equivalencias	
-	-
Especificaciones	
16 VÁLVULAS	



JUNTA DISTRIBUCIÓN	DJ820
	1993-1998 2.4 L4
	- - -
	- - -
	- - -
Equivalencias	
-	-
Especificaciones	
16V	

JUNTA DISTRIBUCIÓN	DJ847
	2014-2018 2.5 L4
	2018-2018 3.5 V6
	- - -
	- - -
Equivalencias	
-	-
Especificaciones	
-	

JUNTA ESCAPE	LB51226
	2002-2006 2.5 L4
	- - -
	- - -
	- - -
Equivalencias	
-	-
Especificaciones	
COCOL	

JUNTA MÚLTIPLE ADMISIÓN	MS41245
	2007-2012 2.5 L4
	- - -
	- - -
	- - -
Equivalencias	
-	-
Especificaciones	
DOHC QR25DE	



JUNTA MÚLTIPLE ADMISIÓN	MU420A
	1993-1998 2.4 L4
	- - -
	- - -
	- - -
Equivalencias	
-	-
Especificaciones	
16 VÁLVULAS	



JUNTA MÚLTIPLE ADMISIÓN	MU420A1
	1993-1998 2.4 L4
	- - -
	- - -
	- - -
Equivalencias	
-	-
Especificaciones	
16 VÁLVULAS	



JUNTA MÚLTIPLE ADMISIÓN	MU430A
	1999-2001 2.4 L4
	- - -
	- - -
	- - -
Equivalencias	
-	-
Especificaciones	
16 VÁLVULAS	



JUNTA MÚLTIPLE ADMISIÓN	MU433A
	1993-2001 2.4 L4
	- - -
	- - -
	- - -
Equivalencias	
DC	-
MS41233A	-
Especificaciones	
16 VÁLVULAS	







JUNTA MÚLTIPLE ADMISIÓN	MU434A
	2002-2007 2.5 L4
	- - - -
	- - - -
	- - - -
Equivalencias	
DC	-
MS41235A	-
Especificaciones	
16 VÁLVULAS	
	

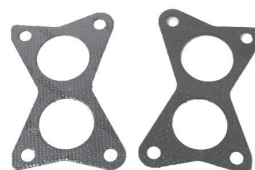

JUNTA MÚLTIPLE ADMISIÓN	MU435A
	2002-2018 3.5 V6
	- - - -
	- - - -
	- - - -
Equivalencias	
-	-
-	-
Especificaciones	
24 VÁLVULAS	
	



JUNTA MÚLTIPLE ADMISIÓN	MU436A
	2008-2013 2.5 L4
	- - - -
	- - - -
	- - - -
Equivalencias	
-	-
-	-
Especificaciones	
16 VÁLVULAS	
	

JUNTA MÚLTIPLE ADMISIÓN	MU447A
	2014-2018 2.5 L4
	- - - -
	- - - -
	- - - -
Equivalencias	
-	-
-	-
Especificaciones	
16 VÁLVULAS	
	



JUNTA MÚLTIPLE ESCAPE	MU420E
	1993-1998 2.4 L4
	- - - -
	- - - -
	- - - -
Equivalencias	
-	-
-	-
Especificaciones	
16 VÁLVULAS	
	



JUNTA MÚLTIPLE ESCAPE	MU430E
	1993-2001 2.4 L4
	- - - -
	- - - -
	- - - -
Equivalencias	
DC	-
MS41232E	-
Especificaciones	
16 VÁLVULAS	
	

JUNTA MÚLTIPLE ESCAPE	MU434E
	2002-2007 2.5 L4
	- - - -
	- - - -
	- - - -
Equivalencias	
DC	-
MS41235E	-
Especificaciones	
16 VÁLVULAS	
	

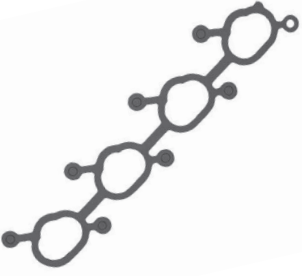
JUNTA MÚLTIPLE ESCAPE	MU435E
	2002-2018 3.5 V6
	- - - -
	- - - -
	- - - -
Equivalencias	
DC	-
MS41236E	-
Especificaciones	
24 VÁLVULAS	
	



JUNTA MÚLTIPLE ESCAPE	MU436E
	2008-2013 2.5 L4
	- - -
	- - -
	- - -
Equivalencias	
-	-
Especificaciones	
16 VÁLVULAS	
	



JUNTA MÚLTIPLE ESCAPE	MU447E
	2014-2018 2.5 L4
	- - -
	- - -
	- - -
Equivalencias	
-	-
Especificaciones	
16 VÁLVULAS	
	



JUNTA PLENO	MU433P
	1993-2001 2.4 L4
	- - -
	- - -
	- - -
Equivalencias	
DC	-
MS41233P	-
Especificaciones	
16 VÁLVULAS	
	

JUNTA PLENO	MU434P
	2002-2007 2.5 L4
	- - -
	- - -
	- - -
Equivalencias	
-	-
Especificaciones	
16 VÁLVULAS	
	

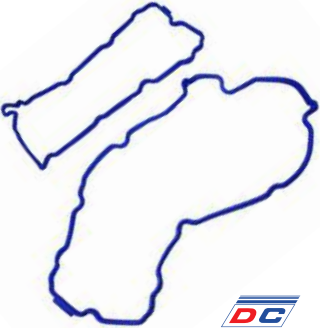
JUNTA PLENO	MU435P
	2002-2018 3.5 V6
	- - -
	- - -
	- - -
Equivalencias	
-	-
Especificaciones	
24 VÁLVULAS	
	

JUNTA PLENO	MU436P
	2008-2013 2.5 L4
	- - -
	- - -
	- - -
Equivalencias	
DC	-
MS41245P	-
Especificaciones	
16 VÁLVULAS	
	

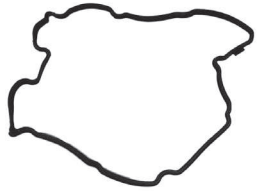

JUNTA PUNTERÍAS	VS312361R
	2007-2016 3.5 V6
	- - -
	- - -
	- - -
Equivalencias	
-	-
Especificaciones	
DOHC VQ35DE	
	

JUNTA PUNTERÍAS	VS31236R
	2006-2006 3.5 V6
	- - -
	- - -
	- - -
Equivalencias	
TF-VICTOR	TF-VICTOR
PS335D	PS335I
Especificaciones	
DOHC VQ35DE INCLUYE AMBAS JUNTAS	
	



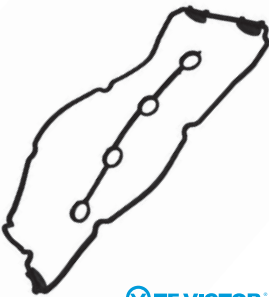

JUNTA PUNTERÍAS	PS320
	1993-1998 2.4 L4
	- - -
	- - -
	- - -
Equivalencias	
-	-
Especificaciones	
16 VÁLVULAS	
	

JUNTA PUNTERÍAS	PS330
	1999-2001 2.4 L4
	- - -
	- - -
	- - -
Equivalencias	
-	-
Especificaciones	
16 VÁLVULAS	
	

JUNTA PUNTERÍAS	PS3331
	1993-2001 2.4 L4
	- - -
	- - -
	- - -
Equivalencias	
DC	-
VS31233R	-
Especificaciones	
16 VÁLVULAS	
	

JUNTA PUNTERÍAS	PS334
	2002-2007 2.5 L4
	- - -
	- - -
	- - -
Equivalencias	
DC	-
VS31235R	-
Especificaciones	
16 VÁLVULAS	
	

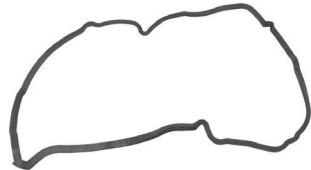
JUNTA PUNTERÍAS	PS336
	2008-2013 2.5 L4
	- - -
	- - -
	- - -
Equivalencias	
DC	-
VS31245R	-
Especificaciones	
16 VÁLVULAS	
	

JUNTA PUNTERÍAS	PS347
	2014-2018 2.5 L4
	- - -
	- - -
	- - -
Equivalencias	
-	-
Especificaciones	
16 VÁLVULAS	
	

KIT DISTRIBUCIÓN	UKD40424
	2001-2001 2.4 L4
	- - -
	- - -
	- - -
Equivalencias	
-	-
Especificaciones	
16 VÁLVULAS KA24DE ENGRANE ÁRBOL SENCILLO	
	

KIT DISTRIBUCIÓN	UKD40424A
	1993-2001 2.4 L4
	- - -
	- - -
	- - -
Equivalencias	
-	-
Especificaciones	
MOTOR KA24DEN Y KA24DE 2.4 L4 16 VÁLVULAS SOHC	
	



KIT DISTRIBUCIÓN	UKD40425
	2002-2006 2.5 L4
	- - -
	- - -
	- - -
Equivalencias	
-	
Especificaciones	
-	

TF VICTOR

LAINA CABEZA	CA20L
	1993-1998 2.4 L4
	- - -
	- - -
	- - -
Equivalencias	
-	
Especificaciones	
16V	

TF VICTOR

LAINA CABEZA	LCA2030
	1999-2001 2.4 L4
	- - -
	- - -
	- - -
Equivalencias	
-	
Especificaciones	
16V	

TF VICTOR

LAINA CABEZA	LCA2035D
	2002-2018 3.5 V6
	- - -
	- - -
	- - -
Equivalencias	
-	
Especificaciones	
24V	

TF VICTOR

LAINA CABEZA	LCA2035I
	2002-2018 3.5 V6
	- - -
	- - -
	- - -
Equivalencias	
-	
Especificaciones	
24V	

TF VICTOR

LAINA CABEZA	LCA2047
	2014-2018 2.5 L4
	2018-2018 3.5 V6
	- - -
	- - -
Equivalencias	
-	
Especificaciones	
-	

TF VICTOR

LAINA CABEZA	LCA30
	1999-2001 2.4 L4
	- - -
	- - -
	- - -
Equivalencias	
-	
Especificaciones	
16V	

TF VICTOR

LAINA CABEZA	LCA34
	2002-2007 2.5 L4
	- - -
	- - -
	- - -
Equivalencias	
-	
Especificaciones	
DOHC 16 VÁLVULAS	

TF VICTOR



Mayoreo en autopartes

METAL BIELA	CB1589P010
	2006-2008 L4
	- - -
	- - -
	- - -
Equivalencias	
MORESA 4B1589010	SEALED POWER 44460P10
Especificaciones	

METAL BIELA	CB1589P020
	2006-2008 L4
	- - -
	- - -
	- - -
Equivalencias	
MORESA 4B1589020	SEALED POWER 44460P20
Especificaciones	

METAL BIELA	CB1589P030
	2006-2008 L4
	- - -
	- - -
	- - -
Equivalencias	
MORESA 4B1589030	SEALED POWER 44460P30
Especificaciones	

METAL BIELA	CB1589PSTD
	2006-2008 L4
	- - -
	- - -
	- - -
Equivalencias	
MORESA 4B1589STD	SEALED POWER 44460PSTD
Especificaciones	

METAL BIELA	CB1858ALSTD
	2006-2007 L4
	- - -
	- - -
	- - -
Equivalencias	
MORESA 4B7005STD	-
Especificaciones	

METAL BIELA	4B1589040
	1993-2001 L4
	- - -
	- - -
	- - -
Equivalencias	
-	-
Especificaciones	
16V ANCHO: 0.7874 PULG	

METAL BIELA	4B700525MM
	2002-2015 L4
	- - -
	- - -
	- - -
Equivalencias	
-	-
Especificaciones	
16V ANCHO: 0.748 PULG	

METAL BIELA	4B700550MM
	2002-2015 L4
	- - -
	- - -
	- - -
Equivalencias	
-	-
Especificaciones	
16V ANCHO: 0.748 PULG	



METAL BIELA	4B700575MM
	2002-2015 2.5 L4
	- - -
	- - -
	- - -
Equivalencias	
-	-
Especificaciones	
16V ANCHO: 0.748 PULG	

METAL BIELA	6B264025MM
	2002-2015 3.5 V6
	- - -
	- - -
	- - -
Equivalencias	
-	-
Especificaciones	
24V ANCHO: 0.6692 PULG	

METAL BIELA	6B264050MM
	2002-2015 3.5 V6
	- - -
	- - -
	- - -
Equivalencias	
-	-
Especificaciones	
24V ANCHO: 0.6692 PULG	

METAL BIELA	6B2640STD
	2002-2015 3.5 V6
	- - -
	- - -
	- - -
Equivalencias	
-	-
Especificaciones	
24V ANCHO: 0.6692 PULG	

METAL CIGÜEÑAL	MS1949P010
	2006-2008 2.4 L4
	- - -
	- - -
	- - -
Equivalencias	
MORESA 5C1949010	SEALED POWER 7285M10
Especificaciones	
DOHC 16V	

METAL CIGÜEÑAL	MS1949P020
	2006-2008 2.4 L4
	- - -
	- - -
	- - -
Equivalencias	
MORESA 5C1949020	-
Especificaciones	
DOHC 16V	

METAL CIGÜEÑAL	MS1949P030
	2006-2008 2.4 L4
	- - -
	- - -
	- - -
Equivalencias	
MORESA 5C1949030	SEALED POWER 7285M30
Especificaciones	
DOHC 16V	

METAL CIGÜEÑAL	MS1949PSTD
	2006-2008 2.4 L4
	- - -
	- - -
	- - -
Equivalencias	
MORESA 5C1949STD	SEALED POWER 7285MSTD
Especificaciones	
DOHC 16V	



METAL CIGÜEÑAL	MS2262PSTD
	2002-2015 3.5 V6
	- - -
	- - -
	- - -
Equivalencias	
MORESA	-
4C2633STD	-
Especificaciones	
DOHC 24 V	

METAL CIGÜEÑAL	MS2263AL010
	2006-2007 2.5 L4
	- - -
	- - -
	- - -
Equivalencias	
MORESA	-
5C700825MM	-
Especificaciones	
-	

METAL CIGÜEÑAL	MS2263AL020
	2006-2007 2.5 L4
	- - -
	- - -
	- - -
Equivalencias	
MORESA	-
5C700850MM	-
Especificaciones	
-	

METAL CIGÜEÑAL	MS2263ALSTD
	2006-2007 2.5 L4
	- - -
	- - -
	- - -
Equivalencias	
MORESA	-
5C7008STD	-
Especificaciones	
-	

METAL CIGÜEÑAL	TW679S
	2002-2011 2.5 L4
	- - -
	- - -
	- - -
Equivalencias	
-	-
Especificaciones	
-	

METAL CIGÜEÑAL	4C263325MM
	2002-2015 3.5 V6
	- - -
	- - -
	- - -
Equivalencias	
-	-
Especificaciones	
24V ANCHO: 791.0 PULG	

METAL CIGÜEÑAL	4C263350MM
	2002-2015 3.5 V6
	- - -
	- - -
	- - -
Equivalencias	
-	-
Especificaciones	
24V ANCHO: 791.0 PULG	

METAL CIGÜEÑAL	5C7008100MM
	2002-2015 2.5 L4
	- - -
	- - -
	- - -
Equivalencias	
-	-
Especificaciones	
16V	



METAL CIGÜEÑAL	5C700875MM												
	<table border="1"> <tr> <td>2002-2015</td> <td>2.5</td> <td>L4</td> </tr> <tr> <td>-</td> <td>-</td> <td>-</td> </tr> <tr> <td>-</td> <td>-</td> <td>-</td> </tr> <tr> <td>-</td> <td>-</td> <td>-</td> </tr> </table>	2002-2015	2.5	L4	-	-	-	-	-	-	-	-	-
2002-2015	2.5	L4											
-	-	-											
-	-	-											
-	-	-											
Equivalencias													
-	-												
Especificaciones													
16V													
MORESA†													

PISTÓN	1001050												
	<table border="1"> <tr> <td>2002-2007</td> <td>2.5</td> <td>L4</td> </tr> <tr> <td>-</td> <td>-</td> <td>-</td> </tr> <tr> <td>-</td> <td>-</td> <td>-</td> </tr> <tr> <td>-</td> <td>-</td> <td>-</td> </tr> </table>	2002-2007	2.5	L4	-	-	-	-	-	-	-	-	-
2002-2007	2.5	L4											
-	-	-											
-	-	-											
-	-	-											
Equivalencias													
-	-												
Especificaciones													
MATERIAL: ALEACIÓN DE ALUMINIO DIAM PISTÓN: 89.462 MM DIAM EXT PERNO: 19.99 MM LONG PERNO: 57.0 MM													
MORESA†													

PISTÓN	1001075												
	<table border="1"> <tr> <td>2002-2007</td> <td>2.5</td> <td>L4</td> </tr> <tr> <td>-</td> <td>-</td> <td>-</td> </tr> <tr> <td>-</td> <td>-</td> <td>-</td> </tr> <tr> <td>-</td> <td>-</td> <td>-</td> </tr> </table>	2002-2007	2.5	L4	-	-	-	-	-	-	-	-	-
2002-2007	2.5	L4											
-	-	-											
-	-	-											
-	-	-											
Equivalencias													
-	-												
Especificaciones													
MATERIAL: ALEACIÓN DE ALUMINIO DIAM PISTÓN: 89.712 MM DIAM EXT PERNO: 19.99 MM LONG PERNO: 57.0 MM													
MORESA†													

PISTÓN	1001STD												
	<table border="1"> <tr> <td>2002-2007</td> <td>2.5</td> <td>L4</td> </tr> <tr> <td>-</td> <td>-</td> <td>-</td> </tr> <tr> <td>-</td> <td>-</td> <td>-</td> </tr> <tr> <td>-</td> <td>-</td> <td>-</td> </tr> </table>	2002-2007	2.5	L4	-	-	-	-	-	-	-	-	-
2002-2007	2.5	L4											
-	-	-											
-	-	-											
-	-	-											
Equivalencias													
-	-												
Especificaciones													
MATERIAL: ALEACIÓN DE ALUMINIO DIAM PISTÓN: 88.962 MM DIAM EXT PERNO: 19.99 MM LONG PERNO: 57.0 MM													
MORESA†													

PISTÓN	1048050												
	<table border="1"> <tr> <td>2007-2017</td> <td>2.5</td> <td>L4</td> </tr> <tr> <td>-</td> <td>-</td> <td>-</td> </tr> <tr> <td>-</td> <td>-</td> <td>-</td> </tr> <tr> <td>-</td> <td>-</td> <td>-</td> </tr> </table>	2007-2017	2.5	L4	-	-	-	-	-	-	-	-	-
2007-2017	2.5	L4											
-	-	-											
-	-	-											
-	-	-											
Equivalencias													
-	-												
Especificaciones													
MATERIAL: ALEACIÓN DE ALUMINIO DIAM PISTÓN: 89.462 MM DIAM EXT PERNO: 20.0 MM LONG PERNO: 56.6 MM													
MORESA†													

PISTÓN	1048075												
	<table border="1"> <tr> <td>2007-2017</td> <td>2.5</td> <td>L4</td> </tr> <tr> <td>-</td> <td>-</td> <td>-</td> </tr> <tr> <td>-</td> <td>-</td> <td>-</td> </tr> <tr> <td>-</td> <td>-</td> <td>-</td> </tr> </table>	2007-2017	2.5	L4	-	-	-	-	-	-	-	-	-
2007-2017	2.5	L4											
-	-	-											
-	-	-											
-	-	-											
Equivalencias													
-	-												
Especificaciones													
MATERIAL: ALEACIÓN DE ALUMINIO DIAM PISTÓN: 89.712 MM DIAM EXT PERNO: 20.0 MM LONG PERNO: 56.6 MM													
MORESA†													

PISTÓN	1048STD												
	<table border="1"> <tr> <td>2007-2017</td> <td>2.5</td> <td>L4</td> </tr> <tr> <td>-</td> <td>-</td> <td>-</td> </tr> <tr> <td>-</td> <td>-</td> <td>-</td> </tr> <tr> <td>-</td> <td>-</td> <td>-</td> </tr> </table>	2007-2017	2.5	L4	-	-	-	-	-	-	-	-	-
2007-2017	2.5	L4											
-	-	-											
-	-	-											
-	-	-											
Equivalencias													
-	-												
Especificaciones													
MATERIAL: ALEACIÓN DE ALUMINIO DIAM PISTÓN: 88.962 MM DIAM EXT PERNO: 20.0 MM LONG PERNO: 56.6 MM													
MORESA†													

PISTÓN	1189050												
	<table border="1"> <tr> <td>2007-2016</td> <td>2.5</td> <td>L4</td> </tr> <tr> <td>-</td> <td>-</td> <td>-</td> </tr> <tr> <td>-</td> <td>-</td> <td>-</td> </tr> <tr> <td>-</td> <td>-</td> <td>-</td> </tr> </table>	2007-2016	2.5	L4	-	-	-	-	-	-	-	-	-
2007-2016	2.5	L4											
-	-	-											
-	-	-											
-	-	-											
Equivalencias													
-	-												
Especificaciones													
MATERIAL: ALEACIÓN DE ALUMINIO DIAM PISTÓN: 89.462 MM DIAM EXT PERNO: 20.0 MM LONG PERNO: 51.9 MM													
MORESA†													



PISTÓN	1189075
	2007-2016 2.5 L4
	- - -
	- - -
	- - -
Equivalencias	
-	-
Especificaciones	
MATERIAL: ALEACIÓN DE ALUMINIO DIAM PISTÓN: 89.712 MM DIAM EXT PERNO: 20.0 MM LONG PERNO: 51.9 MM	
MORESAS	

PISTÓN	1189STD
	2007-2016 2.5 L4
	- - -
	- - -
	- - -
Equivalencias	
-	-
Especificaciones	
MATERIAL: ALEACIÓN DE ALUMINIO DIAM PISTÓN: 88.962 MM DIAM EXT PERNO: 20.0 MM LONG PERNO: 51.9 MM	
MORESAS	

PISTÓN	1190STD
	2007-2016 3.5 V6
	- - -
	- - -
	- - -
Equivalencias	
-	-
Especificaciones	
MATERIAL: ALEACIÓN DE ALUMINIO DIAM PISTÓN: 95.462 MM DIAM EXT PERNO: 22.0 MM LONG PERNO: 54.0 MM	
MORESAS	

PISTÓN	822050
	1993-1993 2.4 L4
	- - -
	- - -
	- - -
Equivalencias	
VEHYCO	-
P2400NI020	-
Especificaciones	
MATERIAL: ALEACIÓN DE ALUMINIO DIAM PISTÓN: 89.457 MM DIAM EXT PERNO: 21.0 MM LONG PERNO: 66.4 MM	
MORESAS	

PISTÓN	822075
	1993-1993 2.4 L4
	- - -
	- - -
	- - -
Equivalencias	
VEHYCO	-
P2400NI030	-
Especificaciones	
MATERIAL: ALEACIÓN DE ALUMINIO DIAM PISTÓN: 89.707 MM DIAM EXT PERNO: 21.0 MM LONG PERNO: 66.4 MM	
MORESAS	

PISTÓN	822STD
	1993-1993 2.4 L4
	- - -
	- - -
	- - -
Equivalencias	
VEHYCO	-
P2400NISTD	-
Especificaciones	
MATERIAL: ALEACIÓN DE ALUMINIO DIAM PISTÓN: 88.957 MM DIAM EXT PERNO: 21.0 MM LONG PERNO: 66.4 MM	
MORESAS	

PISTÓN	953050
	1998-2001 2.4 L4
	- - -
	- - -
	- - -
Equivalencias	
VEHYCO	DC
P2400N3050	N24005050
Especificaciones	
MATERIAL: ALEACIÓN DE ALUMINIO DIAM PISTÓN: 89.45 MM DIAM EXT PERNO: 21.0 MM LONG PERNO: 57.1 MM	
MORESAS	

PISTÓN	953075
	1998-2001 2.4 L4
	- - -
	- - -
	- - -
Equivalencias	
VEHYCO	-
P2400N3075	-
Especificaciones	
MATERIAL: ALEACIÓN DE ALUMINIO DIAM PISTÓN: 89.7 MM DIAM EXT PER- NO: 21.0 MM LONG PERNO: 57.1 MM	
MORESAS	



PISTÓN	953STD
	📅 1998-2001 🏎️ 2.4 🏎️ L4
	📅 - 🏎️ - 🏎️ -
	📅 - 🏎️ - 🏎️ -
	📅 - 🏎️ - 🏎️ -
Equivalencias	
VEHYCO P2400N3STD	DC N24005STD
Especificaciones	
MATERIAL: ALEACIÓN DE ALUMINIO DIAM PISTÓN: 88.95 MM DIAM EXT PERNO: 21.0 MM LONG PERNO: 57.1 MM	

MORESA+

POLEA CIGÜEÑAL	PC5012
	📅 2002-2010 🏎️ 2.5 🏎️ L4
	📅 - 🏎️ - 🏎️ -
	📅 - 🏎️ - 🏎️ -
	📅 - 🏎️ - 🏎️ -
Equivalencias	
-	-
Especificaciones	
-	

Chromite

PUNTERÍA	M500730
	📅 2007-2016 🏎️ 2.5 🏎️ L4
	📅 - 🏎️ - 🏎️ -
	📅 - 🏎️ - 🏎️ -
	📅 - 🏎️ - 🏎️ -
Equivalencias	
-	-
Especificaciones	
DOHC 16V	

MORESA+

REPUESTO BOMBA ACEITE	RMAK317
	📅 2008-2012 🏎️ 2.5 🏎️ L4
	📅 - 🏎️ - 🏎️ -
	📅 - 🏎️ - 🏎️ -
	📅 - 🏎️ - 🏎️ -
Equivalencias	
-	-
Especificaciones	
16V	

DAI

REPUESTO BOMBA ACEITE	RMAK318
	📅 2007-2009 🏎️ 2.5 🏎️ L4
	📅 - 🏎️ - 🏎️ -
	📅 - 🏎️ - 🏎️ -
	📅 - 🏎️ - 🏎️ -
Equivalencias	
-	-
Especificaciones	
16 VÁLVULAS	

DAI

REPUESTO SOPORTE MOTOR	SD70199
	📅 2002-2006 🏎️ 2.5 🏎️ L4
	📅 - 🏎️ - 🏎️ -
	📅 - 🏎️ - 🏎️ -
	📅 - 🏎️ - 🏎️ -
Equivalencias	
-	-
Especificaciones	
DEL TRAS DIAM BUJE EXT: 90.80 MM ANCHO BUJE EXT: 58.70 MM	

DAI

REPUESTO SOPORTE MOTOR	SD71049
	📅 2002-2006 🏎️ 2.5 🏎️ L4
	📅 - 🏎️ - 🏎️ -
	📅 - 🏎️ - 🏎️ -
	📅 - 🏎️ - 🏎️ -
Equivalencias	
-	-
Especificaciones	
DER DIAM BUJE EXT: 80.86 MM ANCHO BUJE EXT: 50.23 MM PARA SOPORTES SD7247 SD7104	

DAI

REPUESTO SOPORTE MOTOR	SD71419
	📅 2002-2006 🏎️ 2.5 🏎️ L4
	📅 - 🏎️ - 🏎️ -
	📅 - 🏎️ - 🏎️ -
	📅 - 🏎️ - 🏎️ -
Equivalencias	
-	-
Especificaciones	
DEL DIAM BUJE EXT: 85 M ANCHO BUJE EXT: 51 MM PARA SOPORTE FRONTAL SD7141	

DAI





REPUESTO SOPORTE MOTOR	SD71609
	2000-2006 3.5 V6
	- - -
	- - -
	- - -
Equivalencias	
-	-
Especificaciones	
DEL TRAS	





REPUESTO SOPORTE MOTOR	SD76449
	2002-2006 2.5 L4
	- - -
	- - -
	- - -
Equivalencias	
-	-
Especificaciones	
PARA SOPORTE TRASERO SD7644	



RETÉN CIGÜEÑAL	BS71236
	2006-2006 3.5 V6
	- - -
	- - -
	- - -
Equivalencias	
TF-VICTOR RE99477VT	-
Especificaciones	
DOHC VQ35DE	



RETÉN CIGÜEÑAL	BS71236AV
	2006-2006 3.5 V6
	- - -
	- - -
	- - -
Equivalencias	
-	-
Especificaciones	
DOHC VQ35DE	



RETÉN CIGÜEÑAL	228411
	1995-2011 2.5 L4
	- - -
	- - -
	- - -
Equivalencias	
-	-
Especificaciones	
VITON 3.37X4.99X.335	



RETÉN CIGÜEÑAL	710621
	2019-2019 2.0 L4
	- - -
	- - -
	- - -
Equivalencias	
-	-
Especificaciones	



RETÉN CIGÜEÑAL	RE99005SL
	1993-2001 2.4 L4
	- - -
	- - -
	- - -
Equivalencias	
-	-
Especificaciones	
16 VÁLVULAS	



RETÉN CIGÜEÑAL	RE99098VT
	2002-2007 2.5 L4
	- - -
	- - -
	- - -
Equivalencias	
DC RE16059V	-
Especificaciones	
16 VÁLVULAS	





RETÉN CIGÜEÑAL	RE99365VT
	2008-2018 2.5 L4
	- - -
	- - -
	- - -
Equivalencias	
DC	-
RE16059V	-
Especificaciones	
16 VÁLVULAS	

RETÉN CIGÜEÑAL	RE99621VT
	2002-2018 3.5 V6
	- - -
	- - -
	- - -
Equivalencias	
-	-
-	-
Especificaciones	
24 VÁLVULAS	

RETÉN DISTRIBUCIÓN	RE99023PL
	1993-2001 2.4 L4
	2002-2018 2.5 L4
	2018-2018 3.5 V6
	- - -
Equivalencias	
DC	NATIONAL
BS71232	224650
Especificaciones	
KA24DE DOHC 16	

RETÉN DISTRIBUCIÓN	RE99477VT
	2002-2018 3.5 V6
	- - -
	- - -
	- - -
Equivalencias	
-	-
-	-
Especificaciones	
24 VÁLVULAS	

SELLO TUBO BUJÍA	ES91245NS
	2002-2022 2.5 L4
	- - -
	- - -
	- - -
Equivalencias	
-	-
-	-
Especificaciones	
-	

SELLO VÁLVULA	SS81238PA
	2019-2020 2.0 L4
	- - -
	- - -
	- - -
Equivalencias	
TF-VICTOR	-
SV72PL	-
Especificaciones	
DOHC 16V PR25DD	

SELLO VÁLVULA	SV81238
	2019-2020 2.0 L4
	- - -
	- - -
	- - -
Equivalencias	
TF-VICTOR	-
SV72PL	-
Especificaciones	
DOHC 16V PR25DD	

SELLO VÁLVULA	SV106VT
	1993-2001 2.4 L4
	- - -
	- - -
	- - -
Equivalencias	
-	-
-	-
Especificaciones	
16 VÁLVULAS	



SELLO VÁLVULA	SV148VT
	2008-2013 2.5 L4
	- - -
	- - -
	- - -
Equivalencias	
DC	-
SS81236V	-
Especificaciones	
16 VÁLVULAS	

SELLO VÁLVULA	SV65VT
	1993-1998 2.4 L4
	- - -
	- - -
	- - -
Equivalencias	
-	-
-	-
Especificaciones	
16 VÁLVULAS	

SELLO VÁLVULA	SV77VT
	2002-2007 2.5 L4
	- - -
	- - -
	- - -
Equivalencias	
DC	-
SV81236V	-
Especificaciones	
16 VÁLVULAS	

SOPORTE MOTOR	SD12080
	2019-2024 2.5 L4
	- - -
	- - -
	- - -
Equivalencias	
-	-
-	-
Especificaciones	
COMPLEMENTO SOP TRAS	

SOPORTE MOTOR	SD7066
	1993-2001 2.4 L4
	- - -
	- - -
	- - -
Equivalencias	
-	-
-	-
Especificaciones	
DER	

SOPORTE MOTOR	SD7104
	2002-2006 2.5 L4
	- - -
	- - -
	- - -
Equivalencias	
-	-
-	-
Especificaciones	
DER	

SOPORTE MOTOR	SD7141
	2002-2006 2.5 L4
	- - -
	- - -
	- - -
Equivalencias	
-	-
-	-
Especificaciones	
FRONTAL	

SOPORTE MOTOR	SD7247
	2002-2006 3.5 V6
	- - -
	- - -
	- - -
Equivalencias	
-	-
-	-
Especificaciones	
DER	



SOPORTE MOTOR		SD7266EL	
		2002-2006	3.5 V6
		-	-
		-	-
		-	-
Equivalencias			
-	-	-	-
Especificaciones			
FRONTAL			

SOPORTE MOTOR		SD7267EL	
		2002-2006	3.5 V6
		-	-
		-	-
		-	-
Equivalencias			
-	-	-	-
Especificaciones			
TRAS			

SOPORTE MOTOR		SD7458	
		2007-2013	2.5 L4
		-	-
		-	-
		-	-
Equivalencias			
-	-	-	-
Especificaciones			
SUPERIOR DER			

SOPORTE MOTOR		SD7517H	
		2007-2015	2.5 L4
		-	-
		-	-
		-	-
Equivalencias			
-	-	-	-
Especificaciones			
DER			

SOPORTE MOTOR		SD7561H	
		2013-2018	3.5 V6
		-	-
		-	-
		-	-
Equivalencias			
-	-	-	-
Especificaciones			
DER			

SOPORTE MOTOR		SD7604	
		2007-2015	2.5 L4
		-	-
		-	-
		-	-
Equivalencias			
-	-	-	-
Especificaciones			
TORSIÓN SUPERIOR DER			

SOPORTE MOTOR		SD7618	
		1993-2001	2.4 L4
		-	-
		-	-
		-	-
Equivalencias			
-	-	-	-
Especificaciones			
DEL			

SOPORTE MOTOR		SD7644	
		2002-2006	2.5 L4
		-	-
		-	-
		-	-
Equivalencias			
-	-	-	-
Especificaciones			
TRAS			



Mayoreo en autopartes

SOPORTE MOTOR	SD7658
	1983 2007-2018 2.5 L4
	1983 - - -
	1983 - - -
	1983 - - -
Equivalencias	
-	-
Especificaciones	
TRAS	

SOPORTE MOTOR	SD7671
	1983 2013-2018 3.5 V6
	1983 - - -
	1983 - - -
	1983 - - -
Equivalencias	
-	-
Especificaciones	
DEL	

SOPORTE MOTOR	SD7672
	1983 2013-2018 3.5 V6
	1983 - - -
	1983 - - -
	1983 - - -
Equivalencias	
-	-
Especificaciones	
TRAS	

SOPORTE MOTOR	SD8006
	1983 1990-2001 2.4 L4
	1983 - - -
	1983 - - -
	1983 - - -
Equivalencias	
-	-
Especificaciones	
TRASERO	

TAPÓN MONOBLOCK	PF504
	1983 1983-2004 2.4 L4
	1983 - - -
	1983 - - -
	1983 - - -
Equivalencias	
-	-
Especificaciones	

TAPÓN MONOBLOCK	PF513
	1983 1998-2004 2.4 L4
	1983 - - -
	1983 - - -
	1983 - - -
Equivalencias	
-	-
Especificaciones	

TAPÓN MONOBLOCK	PL504
	1983 1983-2004 2.4 L4
	1983 - - -
	1983 - - -
	1983 - - -
Equivalencias	
-	-
Especificaciones	

TAPÓN MONOBLOCK	PL513
	1983 1998-2004 2.4 L4
	1983 - - -
	1983 - - -
	1983 - - -
Equivalencias	
-	-
Especificaciones	



TORNILLO CABEZA	TCA30
	1993-2001 2.4 L4
	- - -
	- - -
	- - -
Equivalencias	
-	-
Especificaciones	
16V	

TF VICTOR

VÁLVULA ADMISIÓN	V7013STD
	2002-2018 2.5 L4
	- - -
	- - -
	- - -
Equivalencias	
-	-
Especificaciones	
LONG: 97.2 MM DIAM VÁLVULA: 35.7 MM DIAM VÁSTAGO: 5.97 MM	

MORESA

VÁLVULA ADMISIÓN	V7041STD
	1993-1998 2.4 L4
	- - -
	- - -
	- - -
Equivalencias	
-	-
Especificaciones	
LONG: 101.32 MM DIAM VÁLVULA: 36.6 MM DIAM VÁSTAGO: 6.97 MM	

MORESA

VÁLVULA ADMISIÓN	V7057STD
	2002-2006 3.5 V6
	- - -
	- - -
	- - -
Equivalencias	
-	-
Especificaciones	
LONG: 96.54 MM DIAM VÁLVULA: 37.2 MM DIAM VÁSTAGO: 5.97 MM	

MORESA

VÁLVULA ADMISIÓN	V7265STD
	2010-2016 3.5 V6
	- - -
	- - -
	- - -
Equivalencias	
-	-
Especificaciones	
LONG: 102.0 MM DIAM VÁLVULA: 36.7 MM DIAM VÁSTAGO: 5.97 MM	

MORESA

VÁLVULA ADMISIÓN	V7267STD
	2007-2020 2.5 L4
	- - -
	- - -
	- - -
Equivalencias	
-	-
Especificaciones	
LONG: 101.69 MM DIAM VÁLVULA: 35.6 MM DIAM VÁSTAGO: 5.96 MM	

MORESA

VÁLVULA ADMISIÓN	V9881STD
	1998-2001 2.4 L4
	- - -
	- - -
	- - -
Equivalencias	
-	-
Especificaciones	
LONG: 101.24 MM DIAM VÁLVULA: 36.6 MM DIAM VÁSTAGO: 6.97 MM	

MORESA

VÁLVULA ESCAPE	S7014STD
	2002-2018 2.5 L4
	- - -
	- - -
	- - -
Equivalencias	
-	-
Especificaciones	
LONG: 98.9 MM DIAM VÁLVULA: 30.8 MM DIAM VÁSTAGO: 5.96 MM	

MORESA



VÁLVULA ESCAPE	S7042STD																								
	<table border="1"> <tr> <td>🏎️</td> <td>1993-1998</td> <td>🏠</td> <td>2.4</td> <td>🏎️</td> <td>L4</td> </tr> <tr> <td>🏎️</td> <td>-</td> <td>🏠</td> <td>-</td> <td>🏎️</td> <td>-</td> </tr> <tr> <td>🏎️</td> <td>-</td> <td>🏠</td> <td>-</td> <td>🏎️</td> <td>-</td> </tr> <tr> <td>🏎️</td> <td>-</td> <td>🏠</td> <td>-</td> <td>🏎️</td> <td>-</td> </tr> </table>	🏎️	1993-1998	🏠	2.4	🏎️	L4	🏎️	-	🏠	-	🏎️	-	🏎️	-	🏠	-	🏎️	-	🏎️	-	🏠	-	🏎️	-
🏎️	1993-1998	🏠	2.4	🏎️	L4																				
🏎️	-	🏠	-	🏎️	-																				
🏎️	-	🏠	-	🏎️	-																				
🏎️	-	🏠	-	🏎️	-																				
Equivalencias																									
-	-																								
-	-																								
Especificaciones																									
LONG: 98.85 MM DIAM VÁLVULA: 31.3 MM DIAM VÁSTAGO: 6.95 MM																									
MORESA†																									

VÁLVULA ESCAPE	S7058STD																								
	<table border="1"> <tr> <td>🏎️</td> <td>2002-2006</td> <td>🏠</td> <td>3.5</td> <td>🏎️</td> <td>V6</td> </tr> <tr> <td>🏎️</td> <td>-</td> <td>🏠</td> <td>-</td> <td>🏎️</td> <td>-</td> </tr> <tr> <td>🏎️</td> <td>-</td> <td>🏠</td> <td>-</td> <td>🏎️</td> <td>-</td> </tr> <tr> <td>🏎️</td> <td>-</td> <td>🏠</td> <td>-</td> <td>🏎️</td> <td>-</td> </tr> </table>	🏎️	2002-2006	🏠	3.5	🏎️	V6	🏎️	-	🏠	-	🏎️	-	🏎️	-	🏠	-	🏎️	-	🏎️	-	🏠	-	🏎️	-
🏎️	2002-2006	🏠	3.5	🏎️	V6																				
🏎️	-	🏠	-	🏎️	-																				
🏎️	-	🏠	-	🏎️	-																				
🏎️	-	🏠	-	🏎️	-																				
Equivalencias																									
-	-																								
-	-																								
Especificaciones																									
LONG: 94.0 MM DIAM VÁLVULA: 31.38 MM DIAM VÁSTAGO: 5.96 MM																									
MORESA†																									

VÁLVULA ESCAPE	S7268STD																								
	<table border="1"> <tr> <td>🏎️</td> <td>2007-2018</td> <td>🏠</td> <td>2.5</td> <td>🏎️</td> <td>L4</td> </tr> <tr> <td>🏎️</td> <td>-</td> <td>🏠</td> <td>-</td> <td>🏎️</td> <td>-</td> </tr> <tr> <td>🏎️</td> <td>-</td> <td>🏠</td> <td>-</td> <td>🏎️</td> <td>-</td> </tr> <tr> <td>🏎️</td> <td>-</td> <td>🏠</td> <td>-</td> <td>🏎️</td> <td>-</td> </tr> </table>	🏎️	2007-2018	🏠	2.5	🏎️	L4	🏎️	-	🏠	-	🏎️	-	🏎️	-	🏠	-	🏎️	-	🏎️	-	🏠	-	🏎️	-
🏎️	2007-2018	🏠	2.5	🏎️	L4																				
🏎️	-	🏠	-	🏎️	-																				
🏎️	-	🏠	-	🏎️	-																				
🏎️	-	🏠	-	🏎️	-																				
Equivalencias																									
-	-																								
-	-																								
Especificaciones																									
LONG: 102.85 MM DIAM VÁLVULA: 30.6 MM DIAM VÁSTAGO: 5.95 MM																									
MORESA†																									

VÁLVULA ESCAPE	S7326STD																								
	<table border="1"> <tr> <td>🏎️</td> <td>2016-2020</td> <td>🏠</td> <td>2.5</td> <td>🏎️</td> <td>L4</td> </tr> <tr> <td>🏎️</td> <td>-</td> <td>🏠</td> <td>-</td> <td>🏎️</td> <td>-</td> </tr> <tr> <td>🏎️</td> <td>-</td> <td>🏠</td> <td>-</td> <td>🏎️</td> <td>-</td> </tr> <tr> <td>🏎️</td> <td>-</td> <td>🏠</td> <td>-</td> <td>🏎️</td> <td>-</td> </tr> </table>	🏎️	2016-2020	🏠	2.5	🏎️	L4	🏎️	-	🏠	-	🏎️	-	🏎️	-	🏠	-	🏎️	-	🏎️	-	🏠	-	🏎️	-
🏎️	2016-2020	🏠	2.5	🏎️	L4																				
🏎️	-	🏠	-	🏎️	-																				
🏎️	-	🏠	-	🏎️	-																				
🏎️	-	🏠	-	🏎️	-																				
Equivalencias																									
-	-																								
-	-																								
Especificaciones																									
LONG: 102.8 MM DIAM VÁLVULA: 30.5 MM DIAM VÁSTAGO: 5.46 MM																									
MORESA†																									

VÁLVULA ESCAPE	S9882STD																								
	<table border="1"> <tr> <td>🏎️</td> <td>1998-2001</td> <td>🏠</td> <td>2.4</td> <td>🏎️</td> <td>L4</td> </tr> <tr> <td>🏎️</td> <td>-</td> <td>🏠</td> <td>-</td> <td>🏎️</td> <td>-</td> </tr> <tr> <td>🏎️</td> <td>-</td> <td>🏠</td> <td>-</td> <td>🏎️</td> <td>-</td> </tr> <tr> <td>🏎️</td> <td>-</td> <td>🏠</td> <td>-</td> <td>🏎️</td> <td>-</td> </tr> </table>	🏎️	1998-2001	🏠	2.4	🏎️	L4	🏎️	-	🏠	-	🏎️	-	🏎️	-	🏠	-	🏎️	-	🏎️	-	🏠	-	🏎️	-
🏎️	1998-2001	🏠	2.4	🏎️	L4																				
🏎️	-	🏠	-	🏎️	-																				
🏎️	-	🏠	-	🏎️	-																				
🏎️	-	🏠	-	🏎️	-																				
Equivalencias																									
-	-																								
-	-																								
Especificaciones																									
LONG: 98.8 MM DIAM VÁLVULA: 31.33 MM DIAM VÁSTAGO: 6.95 MM																									
MORESA†																									

SUSPENSION Y DIRECCION

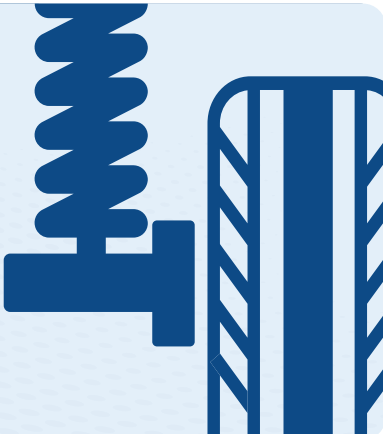



AMORTIGUADOR GAS	832594																								
	<table border="1"> <tr> <td>🏎️</td> <td>2007-2012</td> <td>🏠</td> <td>2.5</td> <td>🏎️</td> <td>L4</td> </tr> <tr> <td>🏎️</td> <td>-</td> <td>🏠</td> <td>-</td> <td>🏎️</td> <td>-</td> </tr> <tr> <td>🏎️</td> <td>-</td> <td>🏠</td> <td>-</td> <td>🏎️</td> <td>-</td> </tr> <tr> <td>🏎️</td> <td>-</td> <td>🏠</td> <td>-</td> <td>🏎️</td> <td>-</td> </tr> </table>	🏎️	2007-2012	🏠	2.5	🏎️	L4	🏎️	-	🏠	-	🏎️	-	🏎️	-	🏠	-	🏎️	-	🏎️	-	🏠	-	🏎️	-
🏎️	2007-2012	🏠	2.5	🏎️	L4																				
🏎️	-	🏠	-	🏎️	-																				
🏎️	-	🏠	-	🏎️	-																				
🏎️	-	🏠	-	🏎️	-																				
Equivalencias																									
-	-																								
-	-																								
Especificaciones																									
TRAS TA																									
BOGE																									

AMORTIGUADOR GAS	832687																								
	<table border="1"> <tr> <td>🏎️</td> <td>2013-2018</td> <td>🏠</td> <td>2.5</td> <td>🏎️</td> <td>L4</td> </tr> <tr> <td>🏎️</td> <td>-</td> <td>🏠</td> <td>-</td> <td>🏎️</td> <td>-</td> </tr> <tr> <td>🏎️</td> <td>-</td> <td>🏠</td> <td>-</td> <td>🏎️</td> <td>-</td> </tr> <tr> <td>🏎️</td> <td>-</td> <td>🏠</td> <td>-</td> <td>🏎️</td> <td>-</td> </tr> </table>	🏎️	2013-2018	🏠	2.5	🏎️	L4	🏎️	-	🏠	-	🏎️	-	🏎️	-	🏠	-	🏎️	-	🏎️	-	🏠	-	🏎️	-
🏎️	2013-2018	🏠	2.5	🏎️	L4																				
🏎️	-	🏠	-	🏎️	-																				
🏎️	-	🏠	-	🏎️	-																				
🏎️	-	🏠	-	🏎️	-																				
Equivalencias																									
-	-																								
-	-																								
Especificaciones																									
TRAS TA																									
BOGE																									



AMORTIGUADOR GAS	MP8177
	1993-2001 2.4 L4
	- - -
	- - -
	- - -
Equivalencias	
-	
Especificaciones	
DEL IZQ TA	

AMORTIGUADOR GAS	MP8178
	1993-2001 2.4 L4
	- - -
	- - -
	- - -
Equivalencias	
-	
Especificaciones	
DEL DER TA	

AMORTIGUADOR GAS	MP8179
	1993-2001 2.4 L4
	- - -
	- - -
	- - -
Equivalencias	
-	
Especificaciones	
TRAS IZQ TA	

AMORTIGUADOR GAS	MP8180
	1993-2001 2.4 L4
	- - -
	- - -
	- - -
Equivalencias	
-	
Especificaciones	
TRAS DER TA	

AMORTIGUADOR GAS	MP8453
	2002-2006 2.5 L4
	- - -
	- - -
	- - -
Equivalencias	
-	
Especificaciones	
DEL IZQ TA FWD	

AMORTIGUADOR GAS	MP8454
	2002-2006 2.5 L4
	- - -
	- - -
	- - -
Equivalencias	
-	
Especificaciones	
DEL DER TA FWD	

AMORTIGUADOR GAS	MP8474
	2002-2006 2.5 L4
	- - -
	- - -
	- - -
Equivalencias	
-	
Especificaciones	
DEL DER TA FWD	

AMORTIGUADOR GAS	MP8475
	2002-2006 2.5 L4
	- - -
	- - -
	- - -
Equivalencias	
-	
Especificaciones	
DEL IZQ TA FWD	



AMORTIGUADOR GAS	MP8499
	2007-2012 2.5 L4
	- - -
	- - -
	- - -
Equivalencias	
-	
Especificaciones	
DEL IZQ TA	

AMORTIGUADOR GAS	MP8500
	2007-2012 2.5 L4
	- - -
	- - -
	- - -
Equivalencias	
-	
Especificaciones	
DEL DER TA	

AMORTIGUADOR GAS	MP8624
	2013-2018 2.5 L4
	- - -
	- - -
	- - -
Equivalencias	
-	
Especificaciones	
DEL DER TA	

AMORTIGUADOR GAS	MP8625
	2013-2018 2.5 L4
	- - -
	- - -
	- - -
Equivalencias	
-	
Especificaciones	
DEL IZQ TA	

BASE AMORTIGUADOR	SD6743KIT
	1993-2001
	- - -
	- - -
	- - -
Equivalencias	
-	
Especificaciones	

BASE AMORTIGUADOR	SD7300KIT
	2002-2006
	- - -
	- - -
	- - -
Equivalencias	
-	
Especificaciones	
DEL IZQ/DER	

BASE AMORTIGUADOR	SD8301KIT
	2007-2013
	- - -
	- - -
	- - -
Equivalencias	
-	
Especificaciones	
DEL IZQ/DER	

BASE AMORTIGUADOR	SD8444KIT
	2013-2018 2.5 L4
	- - -
	- - -
	- - -
Equivalencias	
-	
Especificaciones	
FRONTAL IZQ DER	



BASE AMORTIGUADOR	SD8784KIT
	2019-2024 2.5 L4
	- - - -
	- - - -
	- - - -
Equivalencias	
-	-
Especificaciones	
TRASERA IZO/DER	

BASE AMORTIGUADOR	SD8817
	2019-2024 2.5 L4
	- - - -
	- - - -
	- - - -
Equivalencias	
-	-
Especificaciones	
TRASERA IZO/DER	

BASE AMORTIGUADOR	UDBA13JA0A
	2013-2021 - - -
	- - - -
	- - - -
	- - - -
Equivalencias	
-	-
Especificaciones	
DEL	

BASE AMORTIGUADOR	UDBA1975
	1998-2001 - - -
	- - - -
	- - - -
	- - - -
Equivalencias	
-	-
Especificaciones	
DEL	

BASE AMORTIGUADOR	UDBA6914
	2002-2006 - - -
	- - - -
	- - - -
	- - - -
Equivalencias	
-	-
Especificaciones	
DEL	

BASE AMORTIGUADOR	UDBA8913
	2007-2012 - - -
	- - - -
	- - - -
	- - - -
Equivalencias	
-	-
Especificaciones	
DEL	

BIELETA	UD1316001
	2002-2006 2.5 L4
	- - - -
	- - - -
	- - - -
Equivalencias	
-	-
Especificaciones	
FWD	

BIELETA	UD1316013
	2007-2012 2.5 L4
	- - - -
	- - - -
	- - - -
Equivalencias	
-	-
Especificaciones	
FWD	



BIELETA	UD1316025												
	<table border="1"> <tr> <td>2013-2018</td> <td>2.5</td> <td>L4</td> </tr> <tr> <td>-</td> <td>-</td> <td>-</td> </tr> <tr> <td>-</td> <td>-</td> <td>-</td> </tr> <tr> <td>-</td> <td>-</td> <td>-</td> </tr> </table>	2013-2018	2.5	L4	-	-	-	-	-	-	-	-	-
2013-2018	2.5	L4											
-	-	-											
-	-	-											
-	-	-											
Equivalencias													
-	-												
Especificaciones													
FWD													

BIELETA	UD4852109E00												
	<table border="1"> <tr> <td>1998-2001</td> <td>-</td> <td>-</td> </tr> <tr> <td>-</td> <td>-</td> <td>-</td> </tr> <tr> <td>-</td> <td>-</td> <td>-</td> </tr> <tr> <td>-</td> <td>-</td> <td>-</td> </tr> </table>	1998-2001	-	-	-	-	-	-	-	-	-	-	-
1998-2001	-	-											
-	-	-											
-	-	-											
-	-	-											
Equivalencias													
-	-												
Especificaciones													
INT													

BIELETA	UDEV348												
	<table border="1"> <tr> <td>1993-1997</td> <td>-</td> <td>-</td> </tr> <tr> <td>-</td> <td>-</td> <td>-</td> </tr> <tr> <td>-</td> <td>-</td> <td>-</td> </tr> <tr> <td>-</td> <td>-</td> <td>-</td> </tr> </table>	1993-1997	-	-	-	-	-	-	-	-	-	-	-
1993-1997	-	-											
-	-	-											
-	-	-											
-	-	-											
Equivalencias													
-	-												
Especificaciones													
INT													

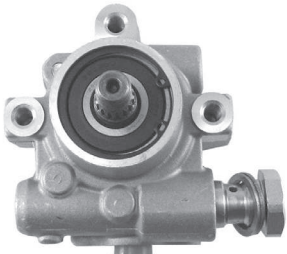
BOMBA DIRECCIÓN HIDRÁULICA	UBDH20012												
	<table border="1"> <tr> <td>2001-2006</td> <td>3.5</td> <td>V6</td> </tr> <tr> <td>-</td> <td>-</td> <td>-</td> </tr> <tr> <td>-</td> <td>-</td> <td>-</td> </tr> <tr> <td>-</td> <td>-</td> <td>-</td> </tr> </table>	2001-2006	3.5	V6	-	-	-	-	-	-	-	-	-
2001-2006	3.5	V6											
-	-	-											
-	-	-											
-	-	-											
Equivalencias													
-	-												
Especificaciones													
LICUADORA S/POLEA S/DEPOSITO													

BOMBA DIRECCIÓN HIDRÁULICA	UBDH40004												
	<table border="1"> <tr> <td>2002-2003</td> <td>2.5</td> <td>L4</td> </tr> <tr> <td>-</td> <td>-</td> <td>-</td> </tr> <tr> <td>-</td> <td>-</td> <td>-</td> </tr> <tr> <td>-</td> <td>-</td> <td>-</td> </tr> </table>	2002-2003	2.5	L4	-	-	-	-	-	-	-	-	-
2002-2003	2.5	L4											
-	-	-											
-	-	-											
-	-	-											
Equivalencias													
-	-												
Especificaciones													
LICUADORA S/POLEA S/DEPOSITO													

BOMBA DIRECCIÓN HIDRÁULICA	UBDH40M00												
	<table border="1"> <tr> <td>2004-2006</td> <td>2.5</td> <td>L4</td> </tr> <tr> <td>-</td> <td>-</td> <td>-</td> </tr> <tr> <td>-</td> <td>-</td> <td>-</td> </tr> <tr> <td>-</td> <td>-</td> <td>-</td> </tr> </table>	2004-2006	2.5	L4	-	-	-	-	-	-	-	-	-
2004-2006	2.5	L4											
-	-	-											
-	-	-											
-	-	-											
Equivalencias													
-	-												
Especificaciones													
LICUADORA S/POLEA S/DEPOSITO													

BUJE	UD1416078												
	<table border="1"> <tr> <td>2015-2018</td> <td>2.5</td> <td>L4</td> </tr> <tr> <td>-</td> <td>-</td> <td>-</td> </tr> <tr> <td>-</td> <td>-</td> <td>-</td> </tr> <tr> <td>-</td> <td>-</td> <td>-</td> </tr> </table>	2015-2018	2.5	L4	-	-	-	-	-	-	-	-	-
2015-2018	2.5	L4											
-	-	-											
-	-	-											
-	-	-											
Equivalencias													
-	-												
Especificaciones													
FWD													

BUJE HORQUILLA	SD545700E010												
	<table border="1"> <tr> <td>1993-2001</td> <td>-</td> <td>-</td> </tr> <tr> <td>-</td> <td>-</td> <td>-</td> </tr> <tr> <td>-</td> <td>-</td> <td>-</td> </tr> <tr> <td>-</td> <td>-</td> <td>-</td> </tr> </table>	1993-2001	-	-	-	-	-	-	-	-	-	-	-
1993-2001	-	-											
-	-	-											
-	-	-											
-	-	-											
Equivalencias													
-	-												
Especificaciones													
INFERIOR GRANDE													



BUJE HORQUILLA	SD5459001E00
	1993-2001  -  -
	-  -  -
	-  -  -
	-  -  -
Equivalencias	
-	-
Especificaciones	
INFERIOR CHICO	
	

BUJE HORQUILLA	SDDAI1416059
	2002-2006  -  -
	-  -  -
	-  -  -
	-  -  -
Equivalencias	
-	-
Especificaciones	
INFERIOR GRANDE S/ SOPORTE	
	

BUJE INFERIOR	UD1416024
	2002-2006  2.5  L4
	-  -  -
	-  -  -
	-  -  -
Equivalencias	
-	-
Especificaciones	
FWD	
	

BUJE INFERIOR	UD1416025
	2002-2006  2.5  L4
	-  -  -
	-  -  -
	-  -  -
Equivalencias	
-	-
Especificaciones	
FWD	
	

BUJE INFERIOR	UD1416050
	2007-2012  2.5  L4
	-  -  -
	-  -  -
	-  -  -
Equivalencias	
-	-
Especificaciones	
FWD	
	

BUJE INFERIOR	UD545704B000
	1998-2001  -  -
	-  -  -
	-  -  -
	-  -  -
Equivalencias	
-	-
Especificaciones	
INF	
	

BUJE INFERIOR	UD5459001E00
	1993-2001  -  -
	-  -  -
	-  -  -
	-  -  -
Equivalencias	
-	-
Especificaciones	
INF CH	
	

CUBRE POLVO	SD63177
	2009-2014  -  -
	-  -  -
	-  -  -
	-  -  -
Equivalencias	
-	-
Especificaciones	
	





CUBRE POLVO	SD63178				
	2009-2014		-		-
	-		-		-
	-		-		-
	-		-		-
Equivalencias					
-					
Especificaciones					
IZQ/DER					

CUBRE POLVO	SD63192				
	2013-2018		-		-
	-		-		-
	-		-		-
	-		-		-
Equivalencias					
-					
Especificaciones					
IZQ/DER					

GOMA BARRA	SD64705				
	2005-2009		-		-
	-		-		-
	-		-		-
	-		-		-
Equivalencias					
-					
Especificaciones					
-					

GOMA BARRA	SD64711				
	2002-2006		-		-
	-		-		-
	-		-		-
	-		-		-
Equivalencias					
-					
Especificaciones					
-					

HORQUILLA	UD1516011				
	1998-2001		-		-
	-		-		-
	-		-		-
	-		-		-
Equivalencias					
-					
Especificaciones					
INF IZQ					

HORQUILLA	UD1516025				
	2007-2012		2.5		L4
	-		-		-
	-		-		-
	-		-		-
Equivalencias					
-					
Especificaciones					
IZQ FWD					

HORQUILLA	UD1516026				
	2007-2012		2.5		L4
	-		-		-
	-		-		-
	-		-		-
Equivalencias					
-					
Especificaciones					
DER FWD					

HORQUILLA	UD1516074				
	2015-2018		2.5		L4
	-		-		-
	-		-		-
	-		-		-
Equivalencias					
-					
Especificaciones					
DER FWD					





HORQUILLA	UD1516075												
	<table border="1"> <tr> <td>2015-2018</td> <td>2.5</td> <td>L4</td> </tr> <tr> <td>-</td> <td>-</td> <td>-</td> </tr> <tr> <td>-</td> <td>-</td> <td>-</td> </tr> <tr> <td>-</td> <td>-</td> <td>-</td> </tr> </table>	2015-2018	2.5	L4	-	-	-	-	-	-	-	-	-
2015-2018	2.5	L4											
-	-	-											
-	-	-											
-	-	-											
Equivalencias													
-													
Especificaciones													
IZQ FWD													

HORQUILLA	UD545007Y000												
	<table border="1"> <tr> <td>2002-2006</td> <td>-</td> <td>-</td> </tr> <tr> <td>-</td> <td>-</td> <td>-</td> </tr> <tr> <td>-</td> <td>-</td> <td>-</td> </tr> <tr> <td>-</td> <td>-</td> <td>-</td> </tr> </table>	2002-2006	-	-	-	-	-	-	-	-	-	-	-
2002-2006	-	-											
-	-	-											
-	-	-											
-	-	-											
Equivalencias													
-													
Especificaciones													
INF DER													

HORQUILLA	UD545017Y000												
	<table border="1"> <tr> <td>2002-2006</td> <td>-</td> <td>-</td> </tr> <tr> <td>-</td> <td>-</td> <td>-</td> </tr> <tr> <td>-</td> <td>-</td> <td>-</td> </tr> <tr> <td>-</td> <td>-</td> <td>-</td> </tr> </table>	2002-2006	-	-	-	-	-	-	-	-	-	-	-
2002-2006	-	-											
-	-	-											
-	-	-											
-	-	-											
Equivalencias													
-													
Especificaciones													
INF IZQ													

KIT TOPE REBOTE	SD0619KIT												
	<table border="1"> <tr> <td>1993-2001</td> <td>-</td> <td>-</td> </tr> <tr> <td>-</td> <td>-</td> <td>-</td> </tr> <tr> <td>-</td> <td>-</td> <td>-</td> </tr> <tr> <td>-</td> <td>-</td> <td>-</td> </tr> </table>	1993-2001	-	-	-	-	-	-	-	-	-	-	-
1993-2001	-	-											
-	-	-											
-	-	-											
-	-	-											
Equivalencias													
-													
Especificaciones													
KIT DEL IZQ/DER													

RESORTE SUSPENSIÓN	UD1816003												
	<table border="1"> <tr> <td>1998-2001</td> <td>-</td> <td>-</td> </tr> <tr> <td>-</td> <td>-</td> <td>-</td> </tr> <tr> <td>-</td> <td>-</td> <td>-</td> </tr> <tr> <td>-</td> <td>-</td> <td>-</td> </tr> </table>	1998-2001	-	-	-	-	-	-	-	-	-	-	-
1998-2001	-	-											
-	-	-											
-	-	-											
-	-	-											
Equivalencias													
-													
Especificaciones													
TRAS													

RESORTE SUSPENSIÓN	UD1816006												
	<table border="1"> <tr> <td>2002-2006</td> <td>-</td> <td>-</td> </tr> <tr> <td>-</td> <td>-</td> <td>-</td> </tr> <tr> <td>-</td> <td>-</td> <td>-</td> </tr> <tr> <td>-</td> <td>-</td> <td>-</td> </tr> </table>	2002-2006	-	-	-	-	-	-	-	-	-	-	-
2002-2006	-	-											
-	-	-											
-	-	-											
-	-	-											
Equivalencias													
-													
Especificaciones													
TRAS													

RESORTE SUSPENSIÓN	UD1816009												
	<table border="1"> <tr> <td>2002-2006</td> <td>-</td> <td>-</td> </tr> <tr> <td>-</td> <td>-</td> <td>-</td> </tr> <tr> <td>-</td> <td>-</td> <td>-</td> </tr> <tr> <td>-</td> <td>-</td> <td>-</td> </tr> </table>	2002-2006	-	-	-	-	-	-	-	-	-	-	-
2002-2006	-	-											
-	-	-											
-	-	-											
-	-	-											
Equivalencias													
-													
Especificaciones													
DEL													

TERMINAL DIRECCIÓN	UD1116001												
	<table border="1"> <tr> <td>2002-2006</td> <td>2.5</td> <td>L4</td> </tr> <tr> <td>-</td> <td>-</td> <td>-</td> </tr> <tr> <td>-</td> <td>-</td> <td>-</td> </tr> <tr> <td>-</td> <td>-</td> <td>-</td> </tr> </table>	2002-2006	2.5	L4	-	-	-	-	-	-	-	-	-
2002-2006	2.5	L4											
-	-	-											
-	-	-											
-	-	-											
Equivalencias													
-													
Especificaciones													
FWD													



TERMINAL DIRECCIÓN	UD1116017												
	<table border="1"> <tr> <td>1998-2001</td> <td>2.5</td> <td>L4</td> </tr> <tr> <td>-</td> <td>-</td> <td>-</td> </tr> <tr> <td>-</td> <td>-</td> <td>-</td> </tr> <tr> <td>-</td> <td>-</td> <td>-</td> </tr> </table>	1998-2001	2.5	L4	-	-	-	-	-	-	-	-	-
1998-2001	2.5	L4											
-	-	-											
-	-	-											
-	-	-											
Equivalencias													
-	-												
Especificaciones													
IZQ FWD													

TERMINAL DIRECCIÓN	UD1116018												
	<table border="1"> <tr> <td>2007-2018</td> <td>2.5</td> <td>L4</td> </tr> <tr> <td>-</td> <td>-</td> <td>-</td> </tr> <tr> <td>-</td> <td>-</td> <td>-</td> </tr> <tr> <td>-</td> <td>-</td> <td>-</td> </tr> </table>	2007-2018	2.5	L4	-	-	-	-	-	-	-	-	-
2007-2018	2.5	L4											
-	-	-											
-	-	-											
-	-	-											
Equivalencias													
-	-												
Especificaciones													
DER FWD													

TERMINAL DIRECCIÓN	UD4852050A00												
	<table border="1"> <tr> <td>1998-2001</td> <td>-</td> <td>-</td> </tr> <tr> <td>-</td> <td>-</td> <td>-</td> </tr> <tr> <td>-</td> <td>-</td> <td>-</td> </tr> <tr> <td>-</td> <td>-</td> <td>-</td> </tr> </table>	1998-2001	-	-	-	-	-	-	-	-	-	-	-
1998-2001	-	-											
-	-	-											
-	-	-											
-	-	-											
Equivalencias													
-	-												
Especificaciones													
EXT													

TERMINAL DIRECCIÓN	UDES3440												
	<table border="1"> <tr> <td>1993-1997</td> <td>-</td> <td>-</td> </tr> <tr> <td>-</td> <td>-</td> <td>-</td> </tr> <tr> <td>-</td> <td>-</td> <td>-</td> </tr> <tr> <td>-</td> <td>-</td> <td>-</td> </tr> </table>	1993-1997	-	-	-	-	-	-	-	-	-	-	-
1993-1997	-	-											
-	-	-											
-	-	-											
-	-	-											
Equivalencias													
-	-												
Especificaciones													

TOPE REBOTE	SD0619												
	<table border="1"> <tr> <td>1993-2001</td> <td>-</td> <td>-</td> </tr> <tr> <td>-</td> <td>-</td> <td>-</td> </tr> <tr> <td>-</td> <td>-</td> <td>-</td> </tr> <tr> <td>-</td> <td>-</td> <td>-</td> </tr> </table>	1993-2001	-	-	-	-	-	-	-	-	-	-	-
1993-2001	-	-											
-	-	-											
-	-	-											
-	-	-											
Equivalencias													
-	-												
Especificaciones													
DEL IZQ/DER													

TOPE REBOTE	SD0620												
	<table border="1"> <tr> <td>1993-1997</td> <td>-</td> <td>-</td> </tr> <tr> <td>-</td> <td>-</td> <td>-</td> </tr> <tr> <td>-</td> <td>-</td> <td>-</td> </tr> <tr> <td>-</td> <td>-</td> <td>-</td> </tr> </table>	1993-1997	-	-	-	-	-	-	-	-	-	-	-
1993-1997	-	-											
-	-	-											
-	-	-											
-	-	-											
Equivalencias													
-	-												
Especificaciones													
DEL IZQ/DER													

TORNILLO ESTABILIZADOR	SD546180Z800												
	<table border="1"> <tr> <td>1993-2001</td> <td>-</td> <td>-</td> </tr> <tr> <td>-</td> <td>-</td> <td>-</td> </tr> <tr> <td>-</td> <td>-</td> <td>-</td> </tr> <tr> <td>-</td> <td>-</td> <td>-</td> </tr> </table>	1993-2001	-	-	-	-	-	-	-	-	-	-	-
1993-2001	-	-											
-	-	-											
-	-	-											
-	-	-											
Equivalencias													
-	-												
Especificaciones													
DEL													

TORNILLO ESTABILIZADOR	UD2116011												
	<table border="1"> <tr> <td>1993-1997</td> <td>2.4</td> <td>L4</td> </tr> <tr> <td>-</td> <td>-</td> <td>-</td> </tr> <tr> <td>-</td> <td>-</td> <td>-</td> </tr> <tr> <td>-</td> <td>-</td> <td>-</td> </tr> </table>	1993-1997	2.4	L4	-	-	-	-	-	-	-	-	-
1993-1997	2.4	L4											
-	-	-											
-	-	-											
-	-	-											
Equivalencias													
-	-												
Especificaciones													
FWD													



TORNILLO ESTABILIZADOR		UD2116016												
	<table border="1"> <tr> <td>2002-2006</td> <td>2.5</td> <td>L4</td> </tr> <tr> <td>-</td> <td>-</td> <td>-</td> </tr> <tr> <td>-</td> <td>-</td> <td>-</td> </tr> <tr> <td>-</td> <td>-</td> <td>-</td> </tr> </table>	2002-2006	2.5	L4	-	-	-	-	-	-	-	-	-	
2002-2006	2.5	L4												
-	-	-												
-	-	-												
-	-	-												
Equivalencias		-	-											
Especificaciones		DER												

TORNILLO ESTABILIZADOR		UD2116017												
	<table border="1"> <tr> <td>2002-2006</td> <td>2.5</td> <td>L4</td> </tr> <tr> <td>-</td> <td>-</td> <td>-</td> </tr> <tr> <td>-</td> <td>-</td> <td>-</td> </tr> <tr> <td>-</td> <td>-</td> <td>-</td> </tr> </table>	2002-2006	2.5	L4	-	-	-	-	-	-	-	-	-	
2002-2006	2.5	L4												
-	-	-												
-	-	-												
-	-	-												
Equivalencias		-	-											
Especificaciones		IZQ												

TORNILLO ESTABILIZADOR		UD2116020												
	<table border="1"> <tr> <td>2002-2006</td> <td>2.5</td> <td>L4</td> </tr> <tr> <td>-</td> <td>-</td> <td>-</td> </tr> <tr> <td>-</td> <td>-</td> <td>-</td> </tr> <tr> <td>-</td> <td>-</td> <td>-</td> </tr> </table>	2002-2006	2.5	L4	-	-	-	-	-	-	-	-	-	
2002-2006	2.5	L4												
-	-	-												
-	-	-												
-	-	-												
Equivalencias		-	-											
Especificaciones		FWD												

TORNILLO ESTABILIZADOR		UD2116036												
	<table border="1"> <tr> <td>2007-2012</td> <td>2.5</td> <td>L4</td> </tr> <tr> <td>-</td> <td>-</td> <td>-</td> </tr> <tr> <td>-</td> <td>-</td> <td>-</td> </tr> <tr> <td>-</td> <td>-</td> <td>-</td> </tr> </table>	2007-2012	2.5	L4	-	-	-	-	-	-	-	-	-	
2007-2012	2.5	L4												
-	-	-												
-	-	-												
-	-	-												
Equivalencias		-	-											
Especificaciones		DER FWD												

TORNILLO ESTABILIZADOR		UD2116037												
	<table border="1"> <tr> <td>2007-2012</td> <td>2.5</td> <td>L4</td> </tr> <tr> <td>-</td> <td>-</td> <td>-</td> </tr> <tr> <td>-</td> <td>-</td> <td>-</td> </tr> <tr> <td>-</td> <td>-</td> <td>-</td> </tr> </table>	2007-2012	2.5	L4	-	-	-	-	-	-	-	-	-	
2007-2012	2.5	L4												
-	-	-												
-	-	-												
-	-	-												
Equivalencias		-	-											
Especificaciones		IZQ FWD												

TORNILLO ESTABILIZADOR		UD2116041												
	<table border="1"> <tr> <td>2007-2022</td> <td>2.5</td> <td>L4</td> </tr> <tr> <td>-</td> <td>-</td> <td>-</td> </tr> <tr> <td>-</td> <td>-</td> <td>-</td> </tr> <tr> <td>-</td> <td>-</td> <td>-</td> </tr> </table>	2007-2022	2.5	L4	-	-	-	-	-	-	-	-	-	
2007-2022	2.5	L4												
-	-	-												
-	-	-												
-	-	-												
Equivalencias		-	-											
Especificaciones		DEL IZQ												

TORNILLO ESTABILIZADOR		UD2116042												
	<table border="1"> <tr> <td>2007-2022</td> <td>2.5</td> <td>L4</td> </tr> <tr> <td>-</td> <td>-</td> <td>-</td> </tr> <tr> <td>-</td> <td>-</td> <td>-</td> </tr> <tr> <td>-</td> <td>-</td> <td>-</td> </tr> </table>	2007-2022	2.5	L4	-	-	-	-	-	-	-	-	-	
2007-2022	2.5	L4												
-	-	-												
-	-	-												
-	-	-												
Equivalencias		-	-											
Especificaciones		DEL DER												

TORNILLO ESTABILIZADOR		UD2116051												
	<table border="1"> <tr> <td>2013-2018</td> <td>2.5</td> <td>L4</td> </tr> <tr> <td>-</td> <td>-</td> <td>-</td> </tr> <tr> <td>-</td> <td>-</td> <td>-</td> </tr> <tr> <td>-</td> <td>-</td> <td>-</td> </tr> </table>	2013-2018	2.5	L4	-	-	-	-	-	-	-	-	-	
2013-2018	2.5	L4												
-	-	-												
-	-	-												
-	-	-												
Equivalencias		-	-											
Especificaciones		TRAS IZQ												



TORNILLO ESTABILIZADOR

UD2116052



2013-2018	2.5	L4
-	-	-
-	-	-
-	-	-

Equivalencias

-	-
-	-

Especificaciones

TRAS DER

**TREN
MOTRIZ**

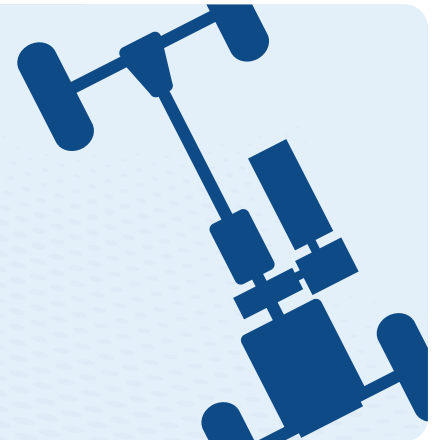

BALERO

NSC00A06LL



2002-2006	2.5	L4
-	-	-
-	-	-
-	-	-

Equivalencias

-	-
-	-

Especificaciones

ALTERNADOR 27X10X11

BALERO DOBLE

DAC42760035SI



1993-2001	2.4	L4
-	-	-
-	-	-
-	-	-

Equivalencias

-	-
-	-

Especificaciones

RUEDA DEL S/ABS 42X76X35

BALERO DOBLE

DAC43760043SI



2002-2006	2.5	L4
-	-	-
-	-	-
-	-	-

Equivalencias

-	-
-	-

Especificaciones

DEL S/ABS 43X76X43

ESPIGA LADO CAJA

RC8470



2007-2012	3.5	V6
-	-	-
-	-	-
-	-	-

Equivalencias

-	-
-	-

Especificaciones

T AUT IZQ 29 ESTRÍAS INT 29
ESTRÍAS EXT

ESPIGA LADO RUEDA

RR9227



1993-2001	2.4	L4
-	-	-
-	-	-
-	-	-

Equivalencias

UNICAR U329227	-
-	-

Especificaciones

AUT C/ABS 27 ESTRÍAS EXT 26
ESTRÍAS INT

ESPIGA LADO RUEDA

RR9294



1993-2001	2.4	L4
-	-	-
-	-	-
-	-	-

Equivalencias

UNICAR U329208	-
-	-

Especificaciones

AUT 27 ESTRÍAS EXT 26 ESTRÍAS
INT



ESPIGA LADO RUEDA		RR9516	
	2007-2012	2.5	L4
	-	-	-
	-	-	-
	-	-	-
Equivalencias			
-	-	-	-
Especificaciones			
MAN 29 ESTRÍAS EXT 35 ESTRÍAS INT			

ESPIGA LADO RUEDA		RR9525	
	2007-2012	3.5	V6
	-	-	-
	-	-	-
	-	-	-
Equivalencias			
-	-	-	-
Especificaciones			
T AUT 27 ESTRÍAS INT 32 ESTRÍAS EXT			

FILTRO TRANSMISIÓN		JT509	
	2002-2006	3.5	V6
	-	-	-
	-	-	-
	-	-	-
Equivalencias			
-	-	-	-
Especificaciones			

FILTRO TRANSMISIÓN		JT527	
	2015-2019	2.5	L4
	-	-	-
	-	-	-
	-	-	-
Equivalencias			
-	-	-	-
Especificaciones			
JF017E JF016E			

MACHETA		BR2604	
	1993-2001	2.4	L4
	-	-	-
	-	-	-
	-	-	-
Equivalencias			
-	-	-	-
Especificaciones			
LADO RUEDA TRANS MAN/AUT DER/IZQ			

MACHETA		BR2605	
	1993-2001	2.4	L4
	-	-	-
	-	-	-
	-	-	-
Equivalencias			
-	-	-	-
Especificaciones			
LADO RUEDA TRANS MAN/AUT DER/IZQ			

MACHETA		SD63206	
	2013-2018	2.5	L4
	-	-	-
	-	-	-
	-	-	-
Equivalencias			
-	-	-	-
Especificaciones			
LADO CAJA IZQ/DER			

RETÉN RUEDA		710108	
	1990-2001	3.5	V6
	-	-	-
	-	-	-
	-	-	-
Equivalencias			
-	-	-	-
Especificaciones			



RETÉN RUEDA	RE99582NT
	1993-2001 2.4 L4
	- - -
	- - -
	- - -
Equivalencias	
-	-
Especificaciones	
-	

RETÉN TRANSMISIÓN	221207
	1993-2013 3.5 V6
	- - -
	- - -
	- - -
Equivalencias	
-	-
Especificaciones	
FLECHA CAMBIOS TRANSEJE AUTOMATICO 4 VELOCIDADES NITRILO .472X.876X.276 	

RETÉN TRANSMISIÓN	224663
	2006-2006 3.5 V6
	- - -
	- - -
	- - -
Equivalencias	
-	-
Especificaciones	
TRANSEJE AUTOMATICO 4 VELOCIDADES POLIACRILATO 1.811X2.496X.33 	

RETÉN TRANSMISIÓN	710124
	1993-2006 2.5 L4
	- - -
	- - -
	- - -
Equivalencias	
-	-
Especificaciones	
VELOCIDADES POLIACRILATO 1.299X2.331X.669 	

RETÉN TRANSMISIÓN	710132
	2007-2018 3.5 V6
	- - -
	- - -
	- - -
Equivalencias	
-	-
Especificaciones	
FLECHA SALIDA IZO TRANSEJE AUTOMATICO 4 VELOCIDADES POLIACRILATO 1.299X2.214X.315 	

SOPORTE TRANSMISIÓN	SD7032
	2002-2006 2.5 L4
	- - -
	- - -
	- - -
Equivalencias	
-	-
Especificaciones	
-	

SOPORTE TRANSMISIÓN	SD7065
	1993-2001 2.4 L4
	- - -
	- - -
	- - -
Equivalencias	
-	-
Especificaciones	
-	

SOPORTE TRANSMISIÓN	SD7395
	2002-2006 3.5 V6
	- - -
	- - -
	- - -
Equivalencias	
-	-
Especificaciones	
T/A	

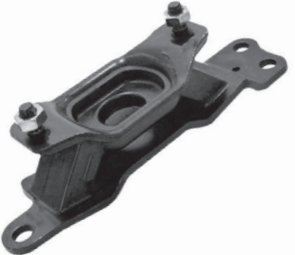

SOPORTE TRANSMISIÓN	SD7516H
	2007-2018 2.5 L4 - - - - - - - - -
Equivalencias	
-	
Especificaciones	
CVT	

SOPORTE TRANSMISIÓN	SD7711
	2013-2018 3.5 V6 - - - - - - - - -
Equivalencias	
-	
Especificaciones	
-	

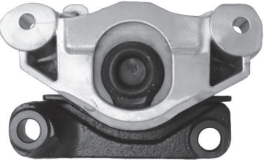
SOPORTE TRANSMISIÓN	SD8973H
	2019-2024 2.0 TURBO L4 - - - - - - - - -
Equivalencias	
-	
Especificaciones	
-	

UNIVERSAL



PLUMA LIMPIAPARABRISAS	GNH16
	2013-2018 2.5 L4 - - - - - - - - -
Equivalencias	
-	
Especificaciones	
CONVENCIONAL DEL 16	

PLUMA LIMPIAPARABRISAS	GNH17
	2002-2012 3.5 V6 2002-2020 2.5 L4 2019-2020 2.0 L4 - - -
Equivalencias	
-	
Especificaciones	
CONVENCIONAL DEL 17	

PLUMA LIMPIAPARABRISAS	GNH28
	2007-2018 2.5 L4 - - - - - - - - -
Equivalencias	
-	
Especificaciones	
CONVENCIONAL DEL 28	

PLUMA LIMPIAPARABRISAS	GNHS17
	2002-2012 3.5 V6 2002-2020 2.5 L4 2019-2020 2.0 L4 - - -
Equivalencias	
-	
Especificaciones	
TIPO BANANA DEL 17	



PLUMA LIMPIAPARABRISAS		H9XW16S	
	1997-2018		
	-		
	-		
	-		
Equivalencias			
GONHER	-		
GNHS16	-		
Especificaciones			
LADO COPILOTO 406 MM 16 PULG CLEANTECH			

PLUMA LIMPIAPARABRISAS		H9XW20S	
	1996-2001		
	-		
	-		
	-		
Equivalencias			
GONHER	-		
GNHS20	-		
Especificaciones			
LADO COPILOTO 508 MM 20 PULG CLEANTECH			

PLUMA LIMPIAPARABRISAS		H9XW21S	
	1996-2001		
	-		
	-		
	-		
Equivalencias			
GONHER	-		
GNHS21	-		
Especificaciones			
LADO PILOTO 533 MM 21 PULG CLEANTECH			

PLUMA LIMPIAPARABRISAS		H9XW26S	
	2002-2006		
	-		
	-		
	-		
Equivalencias			
GONHER	-		
GNHS26	-		
Especificaciones			
LADO PILOTO 660 MM 26 PULG CLEANTECH			

PLUMA LIMPIAPARABRISAS		H9XW28S	
	1997-2018		
	-		
	-		
	-		
Equivalencias			
GONHER	-		
GNHS28	-		
Especificaciones			
LADO PILOTO 711 MM 28 PULG CLEANTECH			

PLUMA LIMPIAPARABRISAS		H9XW398114020	
	1996-2001		
	-		
	-		
	-		
Equivalencias			
GONHER	-		
GNH20	-		
Especificaciones			
LADO PILOTO 508 MM 20 PULG CONVENCIONAL			

PLUMA LIMPIAPARABRISAS		H9XW398114021	
	1996-2001		
	-		
	-		
	-		
Equivalencias			
GONHER	-		
GNH21	-		
Especificaciones			
LADO PILOTO 533 MM 21 PULG CONVENCIONAL			

PLUMA LIMPIAPARABRISAS		H9XW398114026	
	2002-2006		
	-		
	-		
	-		
Equivalencias			
GONHER	-		
GNH26	-		
Especificaciones			
LADO PILOTO 660 MM 26 PULG CONVENCIONAL			

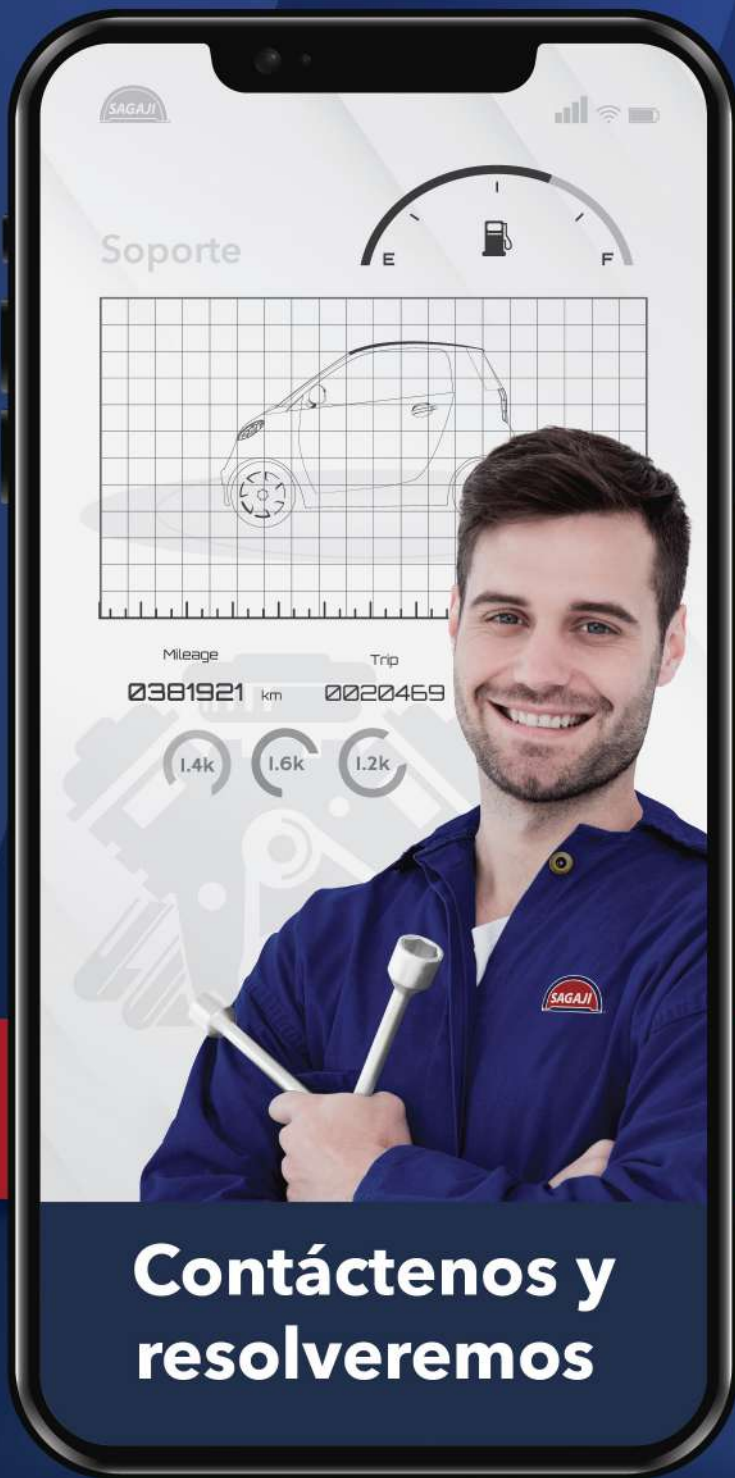

**Contáctenos y
resolveremos**



Soporte
Técnico

 **(55) 3433-4150**

Todas las dudas que tenga con respecto a nuestros productos, aplicaciones y garantías.



Cotice y levante
sus pedidos.

Nuestros asesores

de telemarketing
lo atenderán.

Ventas

Telefónicas

☎ 55-2652-7000





Mayoreo en autopartes

cada vez más cerca de usted

CDMX

(55) 2652 7000
(800) 719 1474

EDOMEX

(55) 9085 3960

León

(477) 774 0337
(800) 712 7985

Oaxaca

(951) 502 1700
(800) 201 0110

Puebla

(222) 223 2500
(800) 627 8030 y 31

Tuxtla

(961) 639 6342
(961) 639 6327

www.sagaji.com.mx



Mayoreo en autopartes

cada vez más cerca de usted

www.sagaji.com.mx

